



Ranger[®] 7000 Scales Instruction Manual



TABLE OF CONTENTS

1	INTRODUCTION	4
1.1	Description	4
1.2	Features	4
1.3	Definition of Signal Warnings and Symbols	4
1.4	Safety Precautions.....	4
2	INSTALLATION	5
2.1	Unpacking	5
2.2	Installing Components	6
2.2.1	Terminal Setup.....	6
2.2.2	Installing the Wind Ring, Weighing Platform	6
2.3	Selecting the Location.....	6
2.4	Connecting Power and Turning ON the Balance	6
2.5	Connecting the Interface.....	7
2.6	Aligning the scale.....	7
2.7	Remote Terminal Operation.....	7
2.8	Separating the Terminal from the Weighing Base.....	8
2.9	Terminal Mounting.....	8
2.10	Initial Calibration.....	8
2.10.1	Internal Calibration.....	8
2.10.2	External Calibration.....	8
3	OPERATION	9
3.1	Overview of Display, Home Screen	9
3.2	Principal Functions and Main Menu.....	10
3.3	Overview of Parts and Features	11
4	APPLICATIONS	12
4.1.	Weighing	12
4.1.1	Application Setup	12
4.1.2	Accumulation	13
4.1.3	Input/Output (I/O) Setup	14
4.2	Parts Counting.....	15
4.2.1	Set the Average Piece Weight (APW).....	15
4.2.2	Application Setup	16
4.2.3	Accumulation	17
4.2.4	Input/Output (I/O) Setup	17
4.3	Check.....	18
4.3.1	Check Weighing (default)	18
4.3.2	Check Counting	20
4.3.3	Application Setup	20
4.3.4	Input/Output (I/O) Setup	22
4.4	Formulation	23
4.4.1	Free Formulation (default)	23
4.4.2	Recipe Formulation	24
4.4.3	Factor and Tolerance Setup	25
4.4.4	Application Setup	25
4.4.5	Input/Output (I/O) Setup	26
4.5	Percent Weighing	27
4.5.1	Establishing a Reference Weight.....	27
4.5.2	Application Setup	28
4.6	Filling.....	28
4.6.1	Target Weight and Set Points Setup.....	29
4.6.2	Application Setup	29
4.6.3	Input/Output (I/O) Setup	30
4.7	Dynamic/Animal Weighing	31
4.7.1	Application Setup	31
4.7.2	Average Time Setup	32
4.7.3	Input/Output (I/O) Setup	33
4.8	Density Determination.....	34
4.8.1	Application Setup	34
4.8.2	Water Temperature / Liquid Density Setup	35

4.9	Differential Weighing.....	36
4.9.1	Application Setup.....	36
4.9.2	Differential Operation.....	37
4.10	Library.....	38
4.10.1	Creating a Library Record.....	38
4.10.2	Retrieving a Library Record.....	39
4.10.3	Editing a Stored Library Record.....	39
4.10.4	Deleting a Stored Library Record.....	39
4.11	Additional Features.....	39
4.11.1	Weigh Below.....	39
5	MENU SETTINGS.....	40
5.1.	Menu Navigation.....	40
5.2.	Main Menu.....	41
5.3.	Calibration.....	41
5.3.1	Calibration Sub-menu.....	41
5.3.2	Zero Calibration.....	41
5.3.3	Span Calibration.....	41
5.3.4	Linearity Calibration.....	42
5.3.5	Internal Calibration.....	42
5.3.6	Automatic Calibration.....	42
5.3.7	GEO Adjustment.....	42
5.4.	Setup.....	43
5.4.1	Scale Set-up Sub-menu.....	43
5.4.2	Reset.....	43
5.4.3	Language.....	43
5.4.4	Power On Unit.....	43
5.4.5	Key Beep.....	43
5.4.6	X10Display.....	43
5.4.7	Barcode Rule.....	44
5.5.	Read Out.....	45
5.5.1	Reset.....	45
5.5.2	Stability.....	45
5.5.3	Zero Range.....	45
5.5.4	Filter level.....	45
5.5.5	Auto Zero Tracking.....	46
5.5.6	Brightness.....	46
5.5.7	Auto Dim.....	46
5.5.8	Auto Sleep.....	46
5.6.	Applications.....	46
5.6.1	Turning an Application ON/OFF.....	46
5.7.	Weighing Units.....	47
5.7.1	Units Sub-menu.....	47
5.7.2	Reset.....	47
5.7.3	Turning a Unit ON/OFF.....	47
5.8.	GLP and GMP Data.....	47
5.8.1	Reset.....	47
5.8.2	Date Format.....	47
5.8.3	Date.....	47
5.8.4	Time Format.....	47
5.8.5	Time.....	48
5.8.6	Project ID.....	48
5.9.	Communications.....	48
5.9.1	Reset.....	48
5.9.2	Baud Rate.....	48
5.9.3	Parity.....	48
5.9.4	Stop Bits.....	48
5.9.5	Handshake.....	49
5.9.6	Alternate Command.....	49
5.9.7	Reset.....	49
5.9.8	Stable Weight Only.....	49
5.9.9	Auto Print.....	49
5.9.10	Print Template.....	50
5.9.11	Edit Template.....	50

5.9.12 Line Feed.....	50
5.9.13 Data Transfer.....	51
5.10. User Profiles.....	52
5.11. Alibi Memory.....	53
5.12. Event Counter.....	54
5.13. Maintenance.....	54
5.13.1 Export Library.....	54
5.13.2 Export User Profile.....	54
5.13.3 Import Library Drives.....	54
5.13.4 Import User Profile.....	54
6 SERIAL COMMUNICATION	55
6.1. Interface Commands.....	55
6.2. RS232 Interface.....	55
6.2.1 Connecting to a Computer.....	55
6.2.2 Connecting to a Serial Printer.....	55
6.3. The USB Interface.....	56
6.3.1 System Requirements.....	56
6.3.2 USB Connections.....	56
6.3.3 Virtual Port Software Installation.....	57
6.4. USB Host.....	57
6.5. Printout Format.....	57
6.6. Printout Examples.....	58
7 LEGAL FOR TRADE.....	60
7.1. Settings.....	60
7.2. Verification.....	60
7.3. Sealing.....	60
8 MAINTENANCE	61
8.1. Calibration.....	61
8.2. Information.....	61
8.3. Cleaning.....	62
8.4. Troubleshooting.....	62
8.5. Service Information.....	62
8.6. Software Updates.....	62
9 TECHNICAL DATA.....	63
9.1. Specifications.....	63
9.2. Drawings and Dimensions.....	64
9.3. Table of Geo Values.....	65
9.4. Options.....	66
9.5. Button Icons List.....	67
10 COMPLIANCE.....	71

1. INTRODUCTION

1.1 Description

The Ranger 7000 scale is a precision weighing instrument that will provide you with years of service if properly cared for. The Ohaus Ranger 7000 scales are available in capacities from 3000 grams to 35 kilograms.

1.2 Features

Modular Design: Ohaus Ranger 7000 scales are composed of two interconnected modules: a Terminal and a Base. Depending on the user's needs, the unit can be operated with the Terminal either attached to, or remote from, the Base, with a single interconnect cord 2 meter long. An optional tower kit and extended cord are also available as accessories.

1.3 Definition of Signal Warnings and Symbols

Safety notes are marked with signal words and warning symbols. These show safety issues and warnings. Ignoring the safety notes may lead to personal injury, damage to the instrument, malfunctions and false results.

Signal Words

WARNING	for a hazardous situation with medium risk, possibly resulting in injuries or death if not avoided.
CAUTION	for a hazardous situation with low risk, resulting in damage to the device or the property or in loss of data, or injuries if not avoided.
Attention Note	For important information about the product For useful information about the product

Warning Symbols



General Hazard



Electrical Shock Hazard



Alternating Current



Information

1.4 Safety Precautions









Caution: Read all safety warnings before installing, making connections, or servicing this equipment. Failure to comply with these warnings could result in personal injury and/or property damage. Retain all instructions for future reference.

- Verify that the input voltage range printed on the data label and the plug type matches the local AC power to be used.
- Only connect models supplied with a grounded power cord to a compatible grounded power receptacle.
- Do not position the scale such that it is difficult to disconnect the power cord from the power receptacle.
- Make sure that the power cord does not pose a potential obstacle or tripping hazard.
- This scale is for indoor use only.
- Use the scale in dry locations only.
- Do not drop loads on the pan.
- Use only approved accessories and peripherals.
- Operate the equipment only under ambient conditions specified in these instructions.
- Disconnect the equipment from the power supply when cleaning.
- Do not operate the equipment in hazardous or unstable environments.
- Service should only be performed by authorized personnel.

2. INSTALLATION

2.1 Unpacking

Carefully remove your Ranger 7000 scale and each of its components from the package. The included components vary depending on the scale model (see table below). Save the packaging to ensure safe storage and transport.

Included Component		Photo	R71MHD3 R71MHD6	R71MD3 R71MD6	R71MHD15 R71MHD35	R71MD15 R71MD35
Terminal			X	X	X	X
Weighing Base			X	X	X	X
Weighing Platform	200 x 200 mm		X			
Weighing Platform	240 x 240 mm			X		
Weighing Platform	311 x 371 mm				X	X
Wind Shield			X			
Compact Disc	Instruction Manual		X	X	X	X

2.2 Installing Components

Refer to the illustrations and instructions below to identify and assemble your Ranger 7000 scale with its components. All components must be assembled before using the scale.

2.2.1 Terminal Setup

When the Ranger 7000 is delivered, the Terminal is already attached (docked) to the Base. No additional setup is necessary. Refer to the illustrations and instructions below to identify and assemble your Ranger 7000 Scale.

Note: The Terminal is identical for all Ranger 7000 Scale models.

2.2.2 Installing the Wind Ring, Weighing Platform

1. Place the Wind Ring in position (R71MHD3, R71MHD6).
2. Place the platform onto the spider.

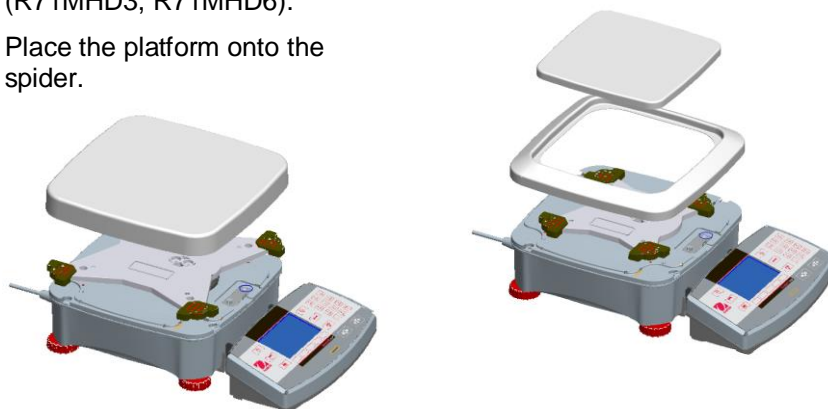

2.3 Selecting the Location

Avoid excessive vibrations, heat sources, air current, or rapid temperature changes. Allow sufficient space.

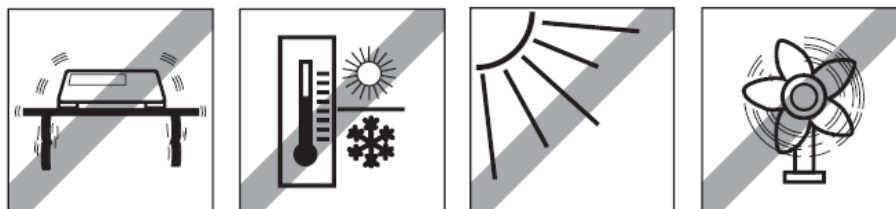

Note: Interface cables connect to the terminal. The terminal can be detached and mounted on a wall or positioned on a table separate from the scale.

2.4 Connecting Power and Turning ON the Scale

The Ranger 7000 comes with an AC power cord. Connect the power cord to a suitable grounded electrical outlet and press the ON button on the side of the base (see figure below).



Power ON button on the side of the base



Attention: Allow equipment to warm up for 60 minutes for optimal weighing performance.

2.5 Connecting the Interface

Use the built-in RS-232 port to connect either to a computer or a printer with a standard (straight-through) serial cable. Or connect using the scale's USB port.

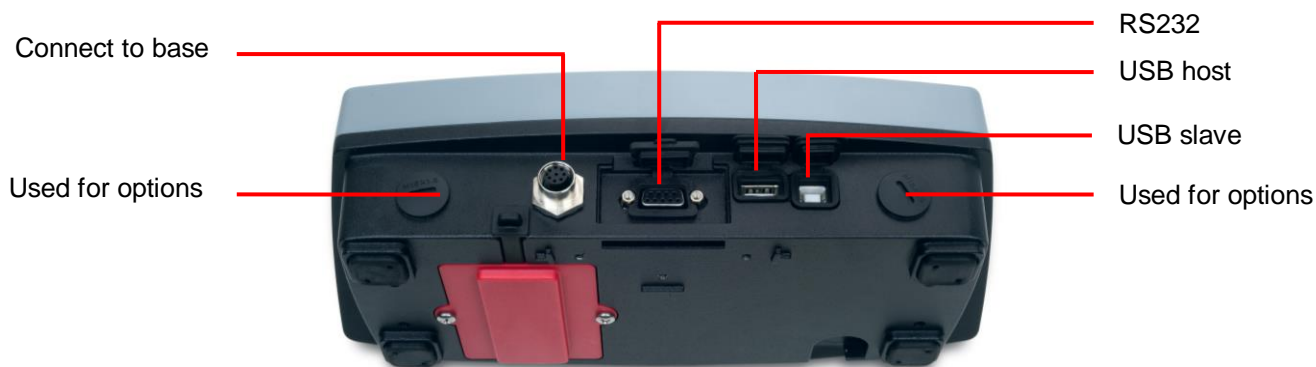

Interface connections on back of Terminal.



Thread terminal cable along cable coils on bottom of scale.
Or pass cable through groove near release button.

2.6 Leveling the scale

Only scales that have been leveled precisely horizontally provide accurate weighing results. The certified scales have a spirit level to simplify alignment.

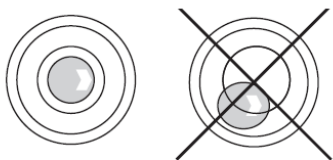

Turn the adjustable feet of the scale until the spirit level's air bubble is inside the inner circle.

2.7 Remote Terminal Operation

The Terminal communicates with the weighing base via the Terminal cable. This cable must be plugged into the Terminal for the Ranger 7000 to display properly. If desired, the Ranger 7000 scale may be operated either with the Terminal attached, or remotely (up to 2 meters away).

2.8 Separating the Terminal from the Weighing Base

1. To detach, press both the Release buttons inward (both at the same time) and gently pull the Terminal towards you (outward) until the Terminal is detached. These Release buttons disengage the two hooks holding the Terminal to the Base. A cable is attached to the Terminal. Take care to not damage or disconnect this cable.
2. To reattach the Terminal, press in the two Release buttons and slide the Terminal into the Base until the Terminal hooks click and engage to hold the Terminal in place.

Release Buttons



Base and Terminal



2.9 Terminal Mounting

If desired, the Terminal may be mounted to a wall or table using fasteners (not supplied) that are appropriate for the type of mounting surface.

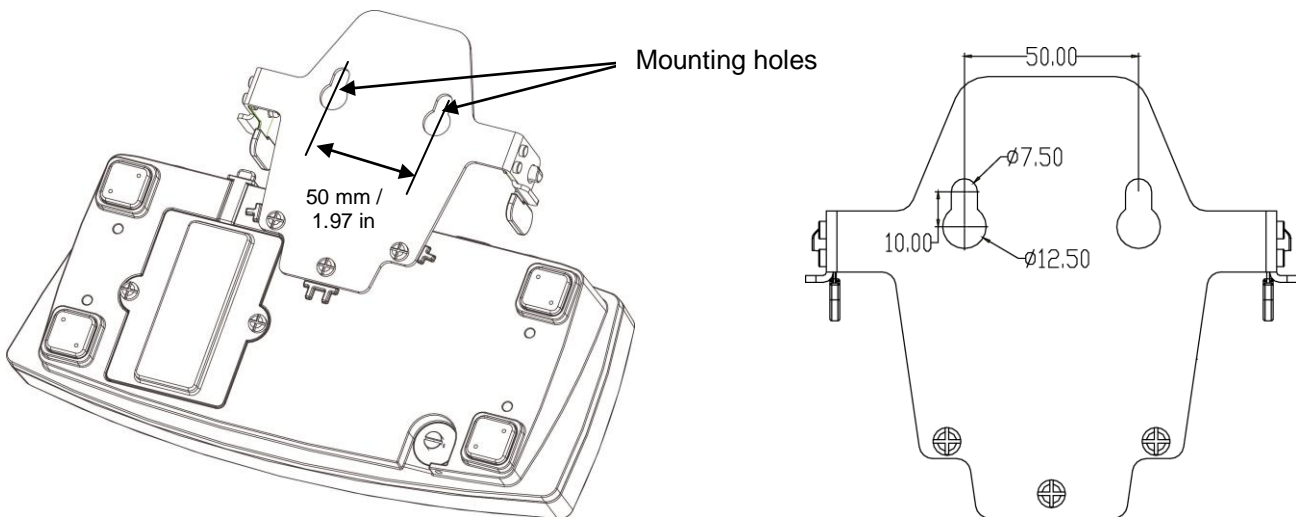

2.10 Initial Calibration

When the Scale is first installed, and when it is moved to another location, it must be calibrated to ensure accurate weighing results.

2.10.1 Internal calibration

R71MHD models have built in AutoCal which can calibrate the scale automatically and does not require calibration masses. If preferred, the scale can be manually calibrated with external masses. Have the appropriate calibration masses available before beginning calibration. Refer to the Calibration Section for masses and calibration procedure.

2.10.2 External calibration

R71MD models can only be manually calibrated with external masses.

3. OPERATION

3.1 Overview of Display, Home Screen

CONTROLS

















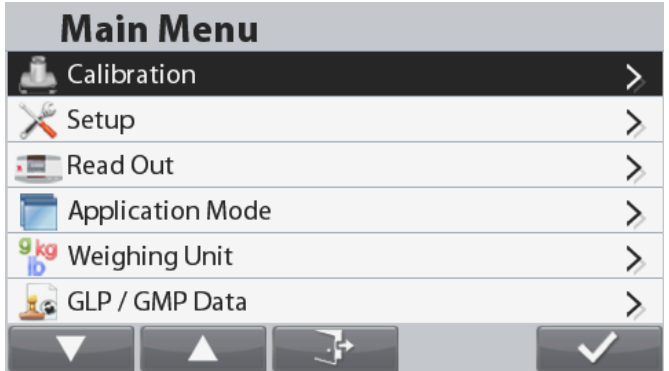

Button	Action
	Enter/Exit the library menu
	Switch between available application modes
	Send the measurement data to available communications ports according to current settings.
	Display information about Application Mode, Library, User and Menu
	Enter/Exit the User menu
	Switch the main weighing unit between the available units
	 Short Press: Input '2'-'9' To Enter 'A' press 2 times. For lower case 'Z', press 5 times.
	 Short Press: Input '0' Long Press: Go to User Login screen
	 Short Press: Input '1' Long Press: Switch platform between scale 1 and scale 2
	 Short Press: Clear character/string when editing string If no input is active, clear the current active library When there is no value added, pressing this button will switch the value sign between positive and negative.
	 Short Press: Input '.', space, '_' To Enter '_' press 3 times.
	Perform Zero operation
	Perform Tare operation When entering the value first and then pressing this button the number input will be set to preset Tare value.



3.2 Principal Functions and Main Menu

MENU & SCREEN NAVIGATION

<p>Press the Menu  button to open the menu list.</p> <p>Press the button below  and  to move down and up the list respectively.</p> <p>To select the highlighted menu item, press . Press  to move back to previous screen.</p>	
 <p>Calibration: Select to view calibration options.</p>	
 <p>Setup: Select to view user preferences.</p>	
 <p>Read Out: Select to view scale settings.</p>	
 <p>Application Modes: Select to view application modes.</p>	
 <p>Weighing Units: Select to view weighing units.</p>	
 <p>GLP and GMP Data: Insert user data for traceability.</p>	 <p>Alibi Memory: Select to view Alibi Memory settings. Note: This menu is only displayed when the Alibi option is installed.</p>
 <p>Communication: Select to view communication settings.</p>	 <p>Maintenance: Select to view Maintenance settings.</p>
 <p>User Profile: Select to view User Profile settings.</p>	 <p>Event Counter: Select to view Maintenance settings.</p>

3.3 Overview of Parts and Features



4. APPLICATIONS

The scale can be configured to operate in various Application modes, see section 5.6 for information on how to activate/deactivate each application mode. Press  to select an activated application. The current application will be shown in the upper left corner of the home screen (See section 3.1).

The Ranger 7000 incorporates the following Applications

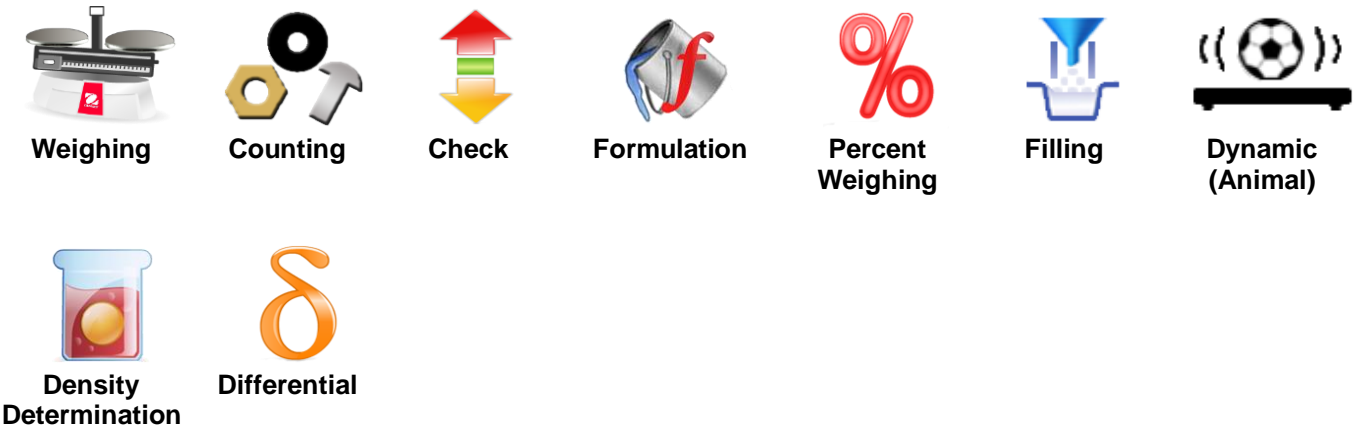

Note: Before using any application, be sure the scale has been leveled and calibrated.

4.1 Weighing

Use this application to determine the weight of items in the selected unit of measure.

Press the  button until **Weighing** is displayed in the upper left portion of the home screen (this application is the default).

Press **Tare** or **Zero** if necessary to begin.

Place objects on the pan to display the weight. When stable, the * appears.

The resulting value is displayed in the main Weighing Line in the active unit of measure.



The **WEIGHING** Home screen

Main Display Line

Reference Fields

Functions



Note: Refer section 9.5, or press the  button for button icon explanation.

4.1.1 Application Setup

The Application can be customized for various user preferences.

Press the button corresponding to the  icon to enter **Configuration**.



The **Configuration** screen is now displayed.

Select the list item and press the button corresponding to , to change the setting as desired.

To return to the Application home screen, press the button corresponding to .

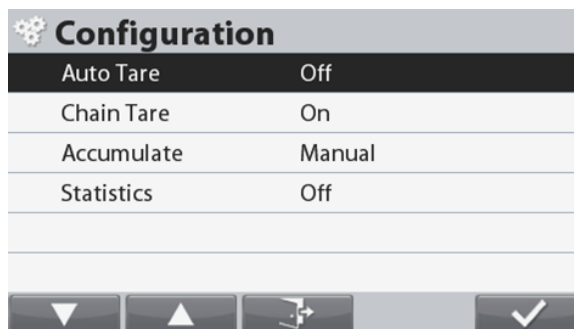

The **Weighing Configurations** are defined below (defaults in **Bold**)

Item	Available Settings	Comments
Auto Tare	On, Off	To enable Automatic Tare
Chain Tare	On , Off	To enable Chain (Continuous) Tare
Accumulate	Off , Automatic, Manual	To enable Accumulation / Totalization
Statistics	On, Off	To enable Statistics

4.1.2 Accumulation

To start Accumulate weighing data, place the item on the pan and press the button corresponding to the icon . The top accumulation icon will start blinking. The load to be accumulated has to be >= 5d and the next accumulation can only start once the pan has been cleared.



Note: The Accumulation icon  will only be shown if Accumulate is set to Manual (see section 4.1.1).



Viewing the Statistics results

When Statistics is set to ON, press the info button  to view the statistics results.

Viewing the Accumulation results

To view the accumulation results, press the info button  then press the button corresponding to the icon .

The **Accumulate Result** screen is displayed.

Note: To return to home screen press the  button.

Press the  button to print Accumulation result.

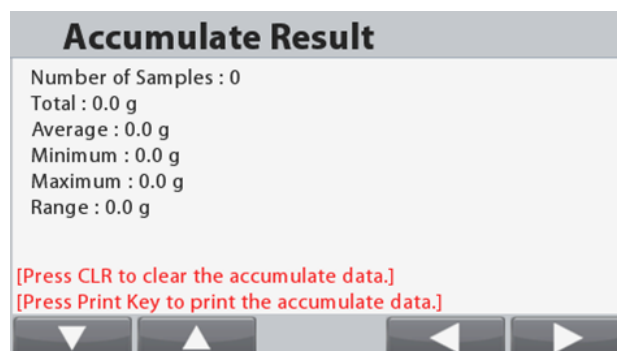

Clearing the Statistics / Accumulation results

To clear the statistic / accumulation results, press the button



A warning message appears. Press the button corresponding to the icon to confirm the deletion or press the button corresponding to the icon to abort the deletion and return to previous screen.

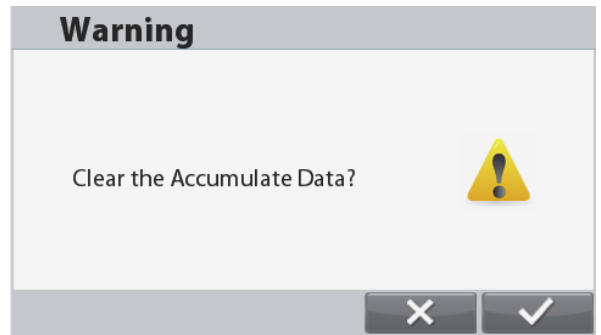

4.1.3 Input/Output (I/O) Setup

The I/O's can be customized for various user preferences.

The I/O's are defined below (defaults in **Bold**).

Item	Available Settings
Discrete Input 1	Off , Zero, Tare, Clear Tare, Print, Unit, Accumulate
Discrete Input 2	Off , Zero, Tare, Clear Tare, Print, Unit, Accumulate
Discrete Output 1	Off , Overload, Underload
Discrete Output 2	Off , Overload, Underload
Discrete Output 3	Off , Overload, Underload
Discrete Output 4	Off , Overload, Underload

Note: The I/O's will only work when the I/O Option Board have been installed. See the Accessory list in section 9.4 for information.

The option I/O board provides two isolated inputs and four dry-contact normally open relay outputs which can be used for simple process weighing.

Press the button to enter the Main Menu.

With the button corresponding to the icon, go down the list and highlight **Application Mode**. Enter this sub-menu by pressing the button corresponding to the icon.

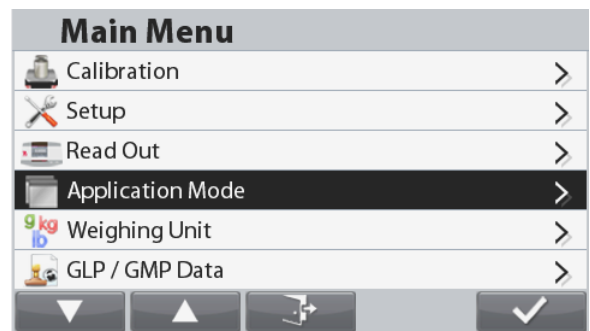

In the Application Mode menu enter the **Weighing** sub-menu.

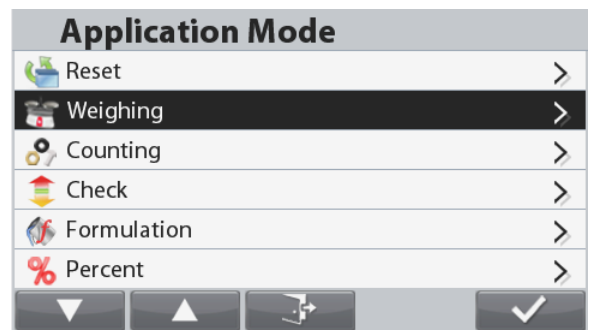

The Weighing sub-menu is now displayed. Select the list item and press the button corresponding to the  icon to change the setting as desired.

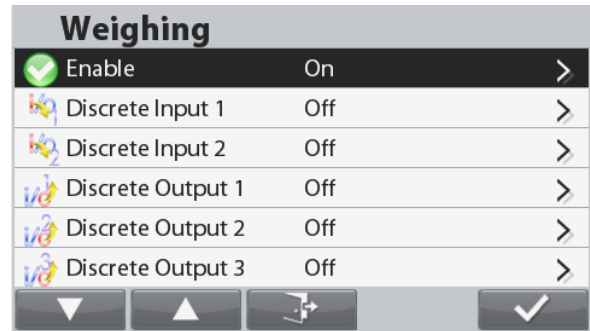

4.2 Counting

Use this application to count samples of uniform weight.

Counting

Press the  button until **Counting** is displayed in the upper left portion of the home screen. The default (or last) Average Piece Weight (APW) is displayed.

Setup APW value according to section 4.2.1 and then place objects on the pan to display the number of pieces.



The **COUNTING** Home screen

Main Display Line

Reference Fields

Functions



Application Icon

Note: Refer section 9.5, or press the  button for button icon explanation.

4.2.1 Set the Average Piece Weight (APW)



Note: It is recommended that the APW is larger than 1d. If APW is between 0.05d and 1d, a warning screen will be displayed and the information line will show 'Low APW'. If APW is less than 0.05d an error screen will appear and the APW value cannot be stored.

There are three ways to set the APW:

1. Positive Sampling

Place the sample on the pan and then key in the number of pieces using the alphanumerical keypad and press the button

corresponding to the  icon to confirm.

Alternatively, press the button corresponding to the  icon. A numeric input screen appears. Key in the desired number of pieces using the alphanumerical keypad, and then press the button corresponding to the icon .

The display returns to the Home screen.

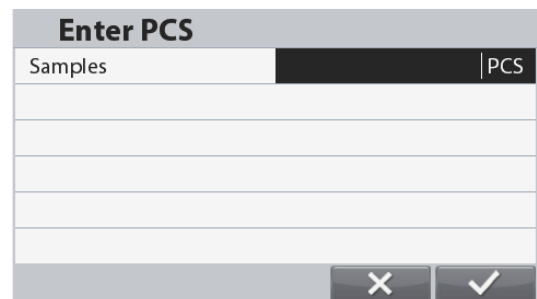

2. Negative Sampling

Place container with the samples on the pan and Tare the scale, a NET 0 will be displayed. Remove the samples from the container; a negative net reading will be displayed. Input the sample size with the numeric keypad and then press the button corresponding to the icon . The value will be displayed on the screen.

Alternatively, press the button corresponding to the icon .

A numeric input screen appears. Key in the desired number of pieces using the alphanumeric keypad, and then press the button corresponding to the  icon. The display returns to the Home screen.

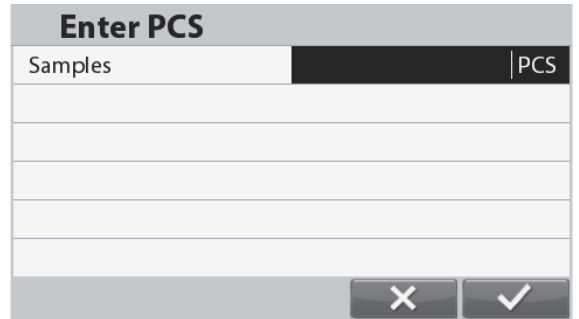

3. Entering a Known APW

Key in the Piece Weight using the alphanumeric keypad and press the button corresponding to the icon  to confirm and store the APW.

Alternatively, press the button corresponding to the icon .

A numeric input screen appears. Key in the Piece Weight using the alphanumeric keypad, then press the button corresponding to the  icon. The display returns to the Home screen with the new APW value displayed in the reference field.

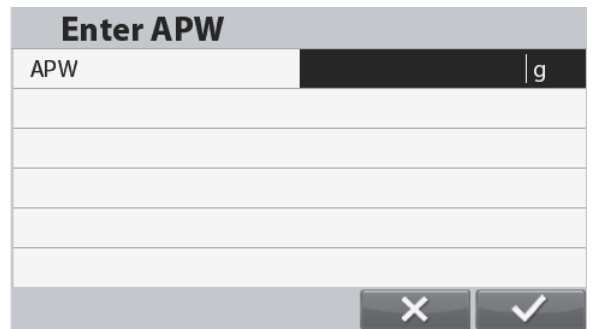

Notes:

When current unit is metric (g, kg), APW unit is g.
When current weighing unit is imperial (lb, oz), APW unit is lb.

4.2.2 Application Setup

The Application can be customized for various user preferences.

Press the button corresponding to the icon  to enter **Configuration**.



The **Configuration** screen is now displayed.

Select the list item and press the button corresponding to the  icon to change the setting as desired.

To return to the Application home screen, press the button corresponding to .

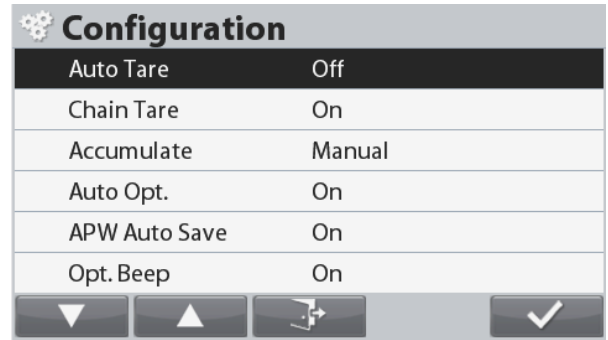

The Counting Configurations are defined below (defaults in **Bold**).

Item	Available Settings	Comments
Auto Tare	On, Off	Turns Automatic Tare on/off
Chain Tare	On , Off	To enable Chain (Continuous)Tare
Accumulate	Off , Automatic, Manual	To enable Accumulation / Totalization
Auto Opt.*	On , Off	To enable Automatic Optimization of APW
APW Auto Save*	On , Off	To enable APW Automatic save
Opt. Beep	On , Off	To enable Optimization Beep

Note: * If APW value is directly entered (not through sampling), this feature does not work.

4.2.3 Accumulation

See section 4.1.2 for details about the Accumulation feature.

4.2.4 Input/Output (I/O) Setup



The I/O's can be customized for various user preferences. The I/O's are defined below (defaults in **Bold**).

Item	Available Settings
Discrete Input 1	Off , Zero, Tare, Clear Tare, Print, Unit, Accumulate
Discrete Input 2	Off , Zero, Tare, Clear Tare, Print, Unit, Accumulate
Discrete Output 1	Off , Overload, Underload
Discrete Output 2	Off , Overload, Underload
Discrete Output 3	Off , Overload, Underload
Discrete Output 4	Off , Overload, Underload

Note: The I/O's will only work when the I/O Option Board have been installed. See the Accessory list in section 9.4 for information.

The option I/O board provides two isolated inputs and four dry-contact normally open relay outputs which can be used for simple process weighing.

Press the  button to enter the Main Menu.

With the button corresponding to the  icon, go down the list and highlight **Application Mode**. Enter this sub-menu by pressing the button corresponding to the  icon.

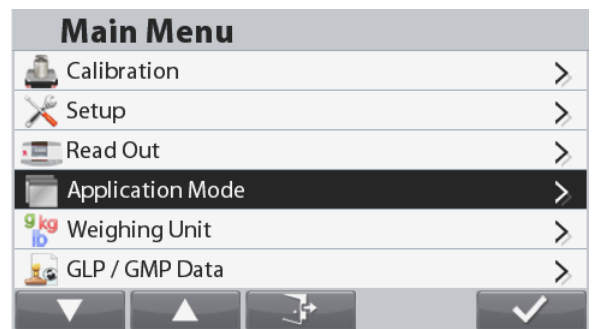

In the Application Mode menu enter the **Counting** sub-menu.

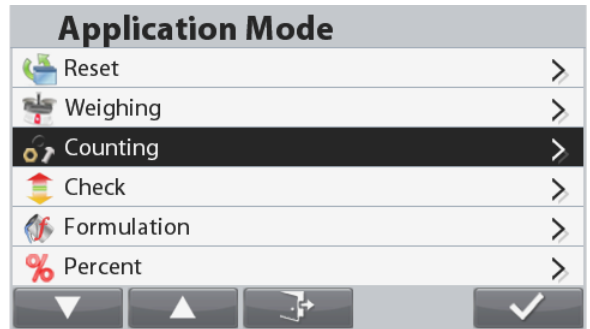

The Counting sub-menu is now displayed. Select the list item and press the button corresponding to the  icon to change the setting as desired.

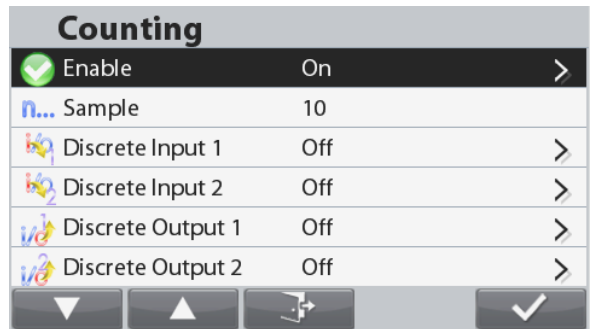

4.3 Check

Check is used to compare the weight or pieces of a sample against target limits.

Press the  button until **Check** is displayed in the upper left portion of the home screen.

Two different modes can be selected: Weight and Pieces.

Three different methods to enter the check limits: Over and Under, Nominal Weight Tolerance, or Nominal Percent Tolerance.

Setup check limits according to section 4.3.1 or 4.3.2. Place object on the pan to check if the weight is within the limits.

4.3.1 Check Weighing (default)

Make sure that the check mode is set to check weighing in the configuration menu .

Place objects on the pan. The **Under/Accept/Over** status is shown in the progress bar area while the actual weight of the item is shown on the main Display Line.

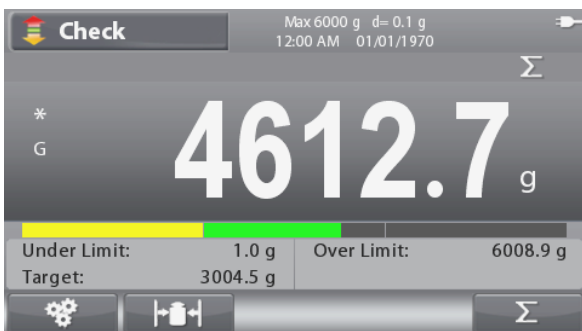

The **CHECK** Home screen

Main Display Line

Reference Fields
Functions





Application Icon

Note: Refer section 9.5, or press the  button for button icon explanation.

Defining Over/Under Limits and Tolerance



Press the button corresponding to the  icon to enter **Limit Setup**.

Select Over or Under Limit and press the button corresponding to the  icon to edit the value.

Enter the desired value for the limit using the alphanumerical keypad. Then press the button corresponding to the  icon to set the value and go back to previous screen.

Alternatively, the limits can be set by Target Weight Tolerance.

To set the tolerance, press the button corresponding to the  icon to enter the **Tolerance setup**.

To switch between **Over/Under Load, Target Weight Tolerance, Target Weight Percentage** press the button corresponding to the  icon. If desired, edit the value by using the alphanumerical keypad and press the button corresponding to the  icon to save the changes and return to the previous screen.

Note: The three set limits methods share the same data.

Edit Limit	
Over Limit	5100.0 g
Under Limit	4800.0 g
▲	▼
↔	↻
✓	

Edit Limit	
Target	4950.0 g
+ Tolerance	150.0 g
- Tolerance	150.0 g
▲	▼
↔	↻
✓	

Edit Limit	
Target	4950.0 g
+ Tolerance	3 %
- Tolerance	3 %
▲	▼
↔	↻
✓	

4.3.2 Check Counting

Press the configuration button  and select Check Mode to Check Counting. Place objects on the pan. The **Under/Accept/Over** status is shown in the progress bar area while the actual number of pieces is shown on the main Display Line.



The **CHECK** Home screen

Main Display Line

Reference Fields

Functions

Note: Refer section 9.5, or press the  button for button icon explanation.

Set the Average Piece Weight (APW)

Note: It is recommended that the APW is larger than 1d. If APW is between 0.05d and 1d, a warning screen will be displayed and the information line will show 'Low APW'. If APW is less than 0.05d an error screen will appear and the APW value cannot be stored.

There are three ways to set the APW, see section 4.2.2 for instructions.

Defining Over/Under Limits

Press the button corresponding to the  icon to enter **Limit Setup**.

Note: See section 4.3.1 for information on how to set the Over/Under limits.

4.3.3 Application Setup

The Application can be customized for various user preferences.



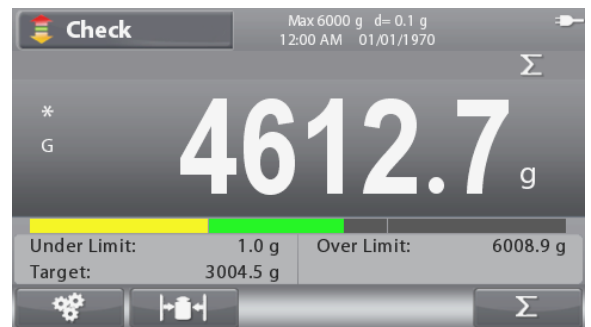

Press the button corresponding to the  icon to enter **Configuration Setup**.



The **Configuration Menu** is now displayed.

Select the list item and press the button corresponding to , to change the setting as desired.

To return to the Application home screen, press the button corresponding to .

Configuration	
Check Mode	Check Weighing
Audible Signal	Off
Auto Opt.	Off
APW Auto Save	Off
Opt. Beep	Off
Auto Tare	Off
	
	

The Check Configurations are defined below (defaults in **Bold**).

Item	Available Settings	Comments
Check Mode	Check Weighing , Check Counting	To set Mode
Audible Signal	Off , Under,Accept,Over, Under&Over	To enable Beeper Signal
Auto Opt*	On , Off	To enable Automatic Optimization of APW
APW Auto Save*	On , Off	To enable APW Automatic save
Opt. Beep*	On , Off	To enable Optimization Beep
Auto Tare	On, Off , On Accept	To enable Automatic Tare 'On Accept' means that if the object weight is within accept range, auto Tare will be performed
Chain Tare	On , Off	To enable Chain (Continuous) Tare
Accumulate	Off , Automatic, Manual	To enable Accumulation / Totalization
Graph Display	Bar , Block	To set Graph Display Type

Note: * Only available in Check Counting mode.

Positive Check

Positive check is used to determine when the material added to the scale is within the target range. In this case the UNDER and OVER limits must be positive values. (The OVER limit must be greater than the UNDER limit.)

Negative Check

Negative check is used to determine when the material removed from the scale is within the target range. In this case the UNDER and OVER limits are both negative values.

The UNDER limit must be greater than the OVER limit (for example: UNDER= -10/OVER= -15).

Place the item to be weighed on the scale and press **Tare**.

Remove a portion of the item until it is within the ACCEPT range.

Zero Check

Zero check is used when comparing subsequent samples to an initial reference sample. In this case, the UNDER limit must be a negative value and the OVER limit must be a positive value.

Place the reference item on the scale and press **Tare**. Remove the reference sample and place the item to be compared on the scale to determine if it is within the ACCEPT range.

4.3.4 Input/Output (I/O) Setup



The I/O's can be customized for various user preferences.

The I/O's are defined below (defaults in **Bold**).

Item	Available Settings
Discrete Input 1	Off , Zero, Tare, Clear Tare, Print, Unit, Accumulate
Discrete Input 2	Off , Zero, Tare, Clear Tare, Print, Unit, Accumulate
Discrete Output 1	Off , Under, Over, Accept, Under/Over
Discrete Output 2	Off , Under, Over, Accept, Under/Over
Discrete Output 3	Off , Under, Over, Accept, Under/Over
Discrete Output 4	Off , Under, Over, Accept, Under/Over

Note: The I/O's will only work when the I/O Option Board have been installed. See the Accessory list in section 9.4 for information. The option I/O board provides two isolated inputs and four dry-contact normally open relay outputs which can be used for simple process weighing.

Press the  button to enter the Main Menu.

With the button corresponding to the  icon, go down the list and highlight **Application Mode**. Enter this sub-menu by pressing the button corresponding to the  icon.

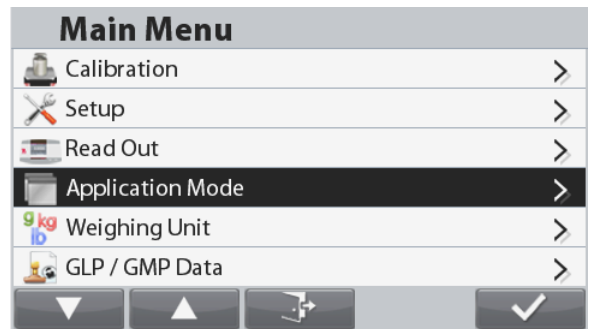

In the Application Mode menu enter the **Check** sub-menu.

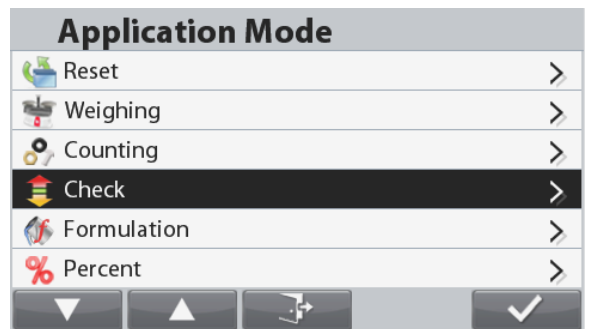

The Check sub-menu is now displayed. Select the list item and press the button corresponding to the  icon to change the setting as desired.

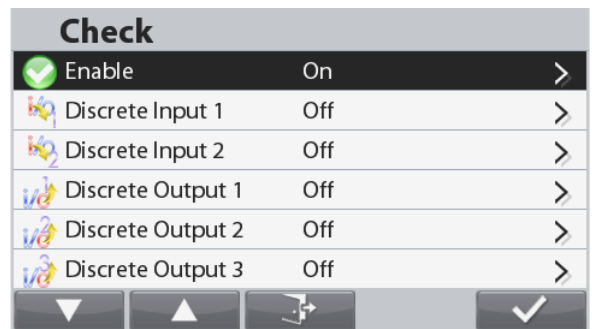

4.4 Formulation

Use this application for compounding and recipe making. The number of components can be 1 to 100. Formulation has two available modes of operation: **Free Formulation** and **Recipe Formulation**.

Press the  button until **Formulation** is displayed in the upper left portion of the home screen.

4.4.1 Free Formulation (default)

This mode of Formulation allows the user to freely add components. A recipe can also be saved and printed when the formulation is finished.



The **FORMULATION** Home screen

Main Display Line

Reference Fields

Functions



Application Icon

Note: Refer section 9.5, or press the  button for button icon explanation.

Press the button corresponding to the  icon to enter the Enter Component screen.

Select the list item and press the button corresponding to the icon , to change the value as desired using the alphanumeric keypad.

The item Name and target Weight are required to be entered.

Press the button corresponding to the icon  to confirm all the values and continue with the formulation.

Note: The  icon will only appear when all the required values have been entered (name and target weight).

The entered target weight will be used as preset tare.

Place the required weight on the pan (add weight until the displayed value reaches zero again).

Press the button corresponding to the icon  to confirm the weight for the current component and to continue adding other components.

Enter comp.	
PN	11
Name	comp.1
Weight	50 g
Tare	0.0 g



Notes: To terminate the formulation process, press the button corresponding to the  icon. If the added weight is over the tolerance limit, compensation will be performed according to the setup in the configuration (At the end, Off, Immediately).

When the compensation is active (At the end or Immediately), if the component added is within tolerance the capacity bar is always in green color.

If one component added is outside the tolerance, the scale will do compensation for next items. In this case, the value displayed is not actual weight and the capacity bar will turn red.

To finish the formulation, press the button corresponding to the icon  and add the last component.

Then the formulation will finish and a Formulation Result screen is displayed.

Formulation Result				
Item	PN	Name	Formu. Wt.	Actual Wt.
001	11	comp.1	50.0	51.3

To print the formulation result press the button corresponding to the icon  or the button .

To save the formulation result, press the button corresponding to the icon .

To return to the main screen, press the button corresponding to the icon .

4.4.2 Recipe Formulation

Make sure the formulation mode is set to recipe (see section 4.4.4 for instructions).

The information line will now show 'Please recall a recipe'

Recall a recipe from the Formulation Library by pressing the button . See section 4.10 for instructions on how to create/recall a Library record.

Press the button corresponding to the  icon or scan a barcode to start formulation.

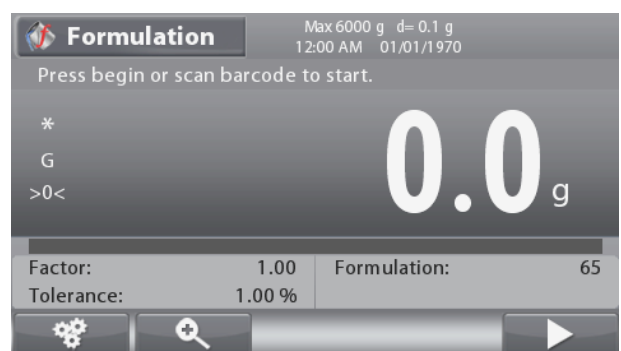

The target weight in each recipe item will be used as preset tare.

Place the required weight on the pan (add weight until the displayed value reaches zero again).

Press the button corresponding to the icon  to confirm the weight for the current component and to continue adding other components or scan another barcode of the next component.



Notes: To terminate the formulation process, press the button corresponding to the  icon. If the added weight is over the tolerance limit, compensation will be performed according to the setup in the configuration (At the end, Off, Immediately).

When the compensation is active (At the end or Immediately), if the component added is within tolerance the capacity bar is always in green color.

If one component added is outside the tolerance, the scale will do compensation for next items. In this case, the value displayed is not actual weight and the capacity bar will turn red.

When all the components of the recipe have been added, the formulation will finish and a Formulation Result screen is displayed.

4.4.3 Factor and Tolerance Setup

Press the button corresponding to the  icon to enter the Parameter screen.

Select the list item and press the button corresponding to the icon , to change the setting as desired using the alphanumerical keypad.

The Component **Factor** can be set to a value between 0.20 and 5.00 with 1.0 being the default.

The **Tolerance** can be set to a value between 0 and 15.0 % with 5 % being the default.

Press the button corresponding to the  icon to return to the Application Home screen.

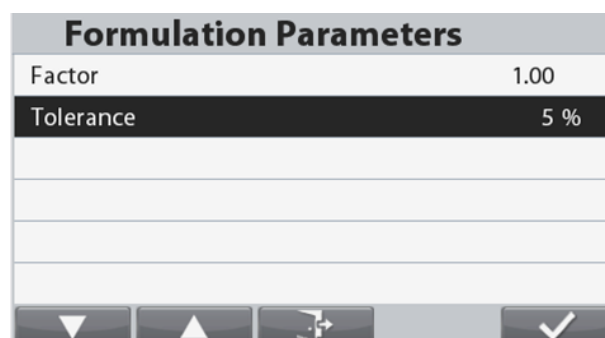

Note: Factor and Tolerance can only be set after the formulation has started.

Tolerance is +/-, for example: Tolerance = 5 % means that the tolerance is the range -5 % ~ +5 %.

4.4.4 Application Setup

The Application can be customized for various user preferences.

Press the button corresponding to the  icon to enter **Configuration**.



The **Configuration Menu** is now displayed.

Select the list item and press the button corresponding to , to change the setting as desired.

To return to the Application home screen, press the button corresponding to .

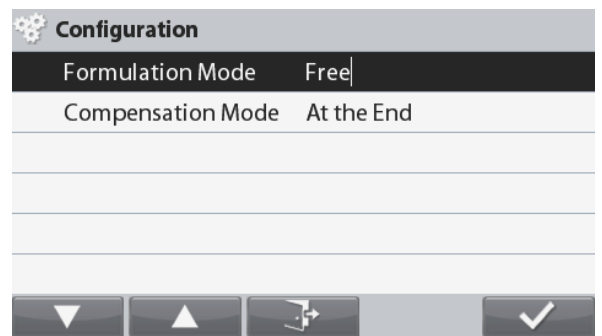

The **Formulation Configurations** are defined below (defaults in **Bold**).

Item	Available Settings	Comments
Formulation Mode	Free , Recipe	To set Mode
Compensation Mode	At the End , Off, Immediately	To set compensation mode

4.4.5 Input/Output (I/O) Setup



The I/O's can be customized for various user preferences.

The I/O's are defined below (defaults in **Bold**).

Item	Available Settings
Discrete Input 1	Off , Zero, Tare, Clear Tare, Quit, Next Item, Last Item
Discrete Input 2	Off , Zero, Tare, Clear Tare, Quit, Next Item, Last Item
Discrete Output 1	Off , Overload, Underload
Discrete Output 2	Off , Overload, Underload
Discrete Output 3	Off , Overload, Underload
Discrete Output 4	Off , Overload, Underload

Note: The I/O's will only work when the I/O Option Board have been installed. See the Accessory list in section 9.4 for information. The option I/O board provides two isolated inputs and four dry-contact normally open relay outputs which can be used for simple process weighing.

Press the  button to enter the Main Menu.

With the button corresponding to the  icon, go down the list and highlight **Application Mode**. Enter this sub-menu by pressing the button corresponding to the  icon.

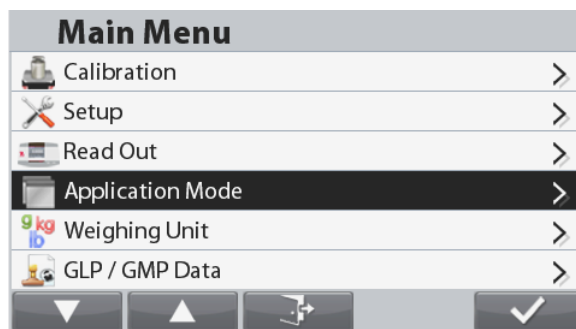

In the Application Mode menu enter the **Formulation** sub-menu.

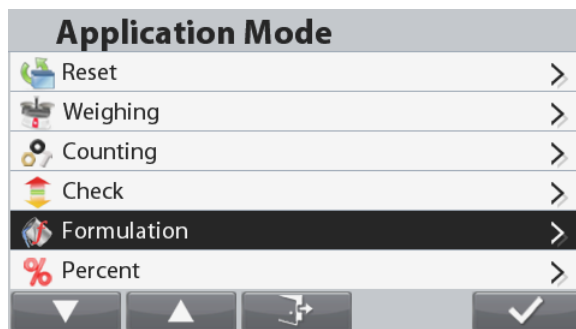

The Formulation sub-menu is now displayed. Select the list item and press the button corresponding to the  icon to change the setting as desired.

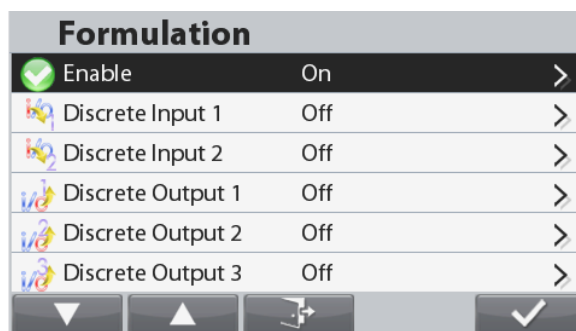

4.5 Percent Weighing

Use Percent Weighing to measure the weight of a sample displayed as a percentage of a pre-established Reference Weight.

Press the  button until **Percent** is displayed in the upper left portion of the home screen.

Establish a reference weight according to section 4.5.1 and then place the objects on the pan to check the percentage.

The default (or last) Reference Weight is displayed.



The **PERCENT** Home screen

Main Display Line

Reference Fields
Functions







Application Icon

Note: Refer section 9.5, or press the  button for button icon explanation.

4.5.1 Establishing a Reference Weight

There are three ways to establish a reference weight:

1. Key in the reference weight value using the alphanumerical keypad and then press the button corresponding to the  icon.
2. Press the button corresponding to the  icon to enter the **Edit Reference Weight** screen. The **Edit Reference Weight** screen is now displayed. Enter the desired value using the alphanumerical keypad and then press the button corresponding to the  icon to save and return to the Application home screen.
3. Place the reference weight on the pan and press the button corresponding to the  icon.

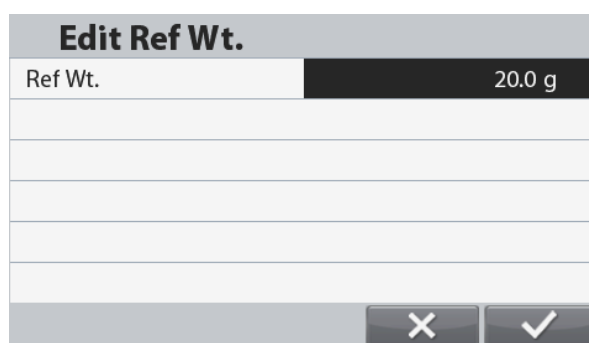

4.5.2 Application Setup

The Application can be customized for various user preferences.

Press the button corresponding to the  icon to enter **Configuration**.



The **Configuration Menu** is now displayed.

Select the list item and press the button corresponding to , to change the setting as desired.

To return to the Application home screen, press the button corresponding to .



The Percent Configurations are defined below (defaults in **Bold**).

Item	Available Settings	Comments
Auto Tare	On, Off	To enable Automatic Tare
Chain Tare	On , Off	To enable Chain Tare (continuous Tare)
Accumulate	Off , Automatic, Manual	To enter Accumulation / Totalization

4.6 Filling

This application allows the user to fill a container to a pre-determined target weight. The progress bar displays the filling status, and within 10 percent of the target value the progress bar converts to fine resolution (+/- 10%) for accurate results.

Press the  button until **Filling** is displayed in the upper left portion of the home screen. The default (or last) Target weight is displayed. Place objects on the pan to begin.



The FILLING Home screen

Main Display Line

Reference Fields
Functions





Application Icon

Note: Refer section 9.5, or press the  button for button icon explanation.

4.6.1 Target Weight and Set Points Setup

There are three ways to set up the Target weight:

1. Place the weight on the pan and press button corresponding to the  icon.
2. Key in the target weight value using the alphanumerical keypad and press the button corresponding to the icon .
3. Press the button corresponding to the  (Set Point) icon to enter the **Edit Settings** screen.

The **Edit Settings** screen is now displayed.

Press the button corresponding to the  icon to switch between Weight, Tolerance and Percent.

Select the list item and press the button corresponding to the icon , to change the setting as desired using the alphanumerical keypad.

To return to the Application home screen, press the button corresponding to the icon .

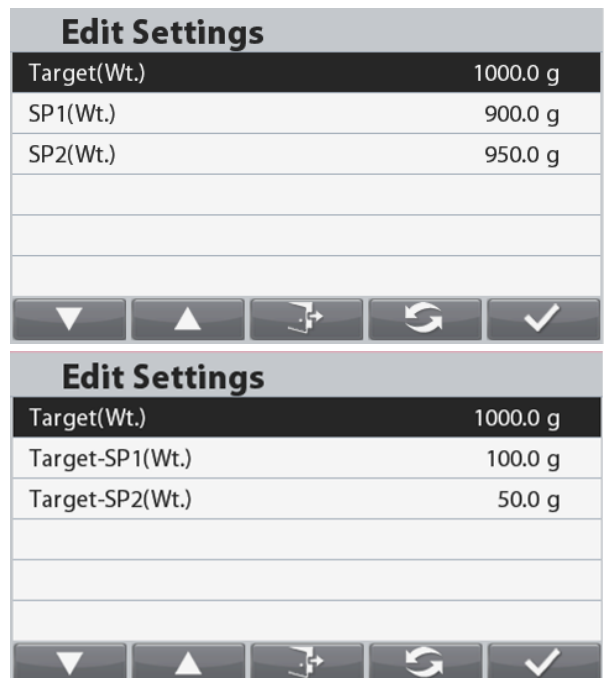

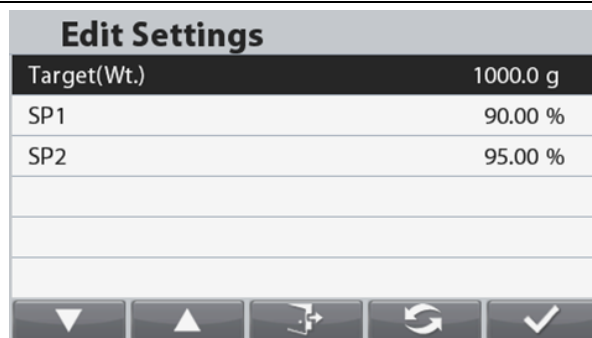

4.6.2 Application Setup

The Application can be customized for various user preferences.

Press the button corresponding to the  icon to enter **Configuration**.



The **Configuration Menu** is now displayed.

Select the list item and press the button corresponding to the , to change the setting as desired.

To return to the Application home screen, press the button corresponding to the .



The **Filling Configurations** are defined below (defaults in **Bold**).

Item	Available Settings	Comments
Auto Tare	On, Off	To enable Automatic Tare
Chain Tare	On , Off	To enable Chain Tare (Continuous Tare)
Accumulate	Off , Manual	To enable Accumulation / Totalization

4.6.3 Input/Output (I/O) Setup

The I/O's can be customized for various user preferences. The I/O's are defined below (defaults in **Bold**).



Item	Available Settings
Discrete Input 1	Off , Zero, Tare, Clear Tare, Print, Start/Stop, Accumulate
Discrete Input 2	Off , Zero, Tare, Print, Start/Stop
Discrete Output 1	Off , SP1, SP2, Target, Alarm
Discrete Output 2	Off , SP1, SP2, Target, Alarm
Discrete Output 3	Off , SP1, SP2, Target, Alarm
Discrete Output 4	Off , SP1, SP2, Target, Alarm

Note:

The output will be reset to normally open when either SP1 or SP2 is reached. The I/O's will only work when the I/O Option Board have been installed. See the Accessory list in section 9.4 for information. The option I/O board provides two isolated inputs and four dry-contact normally open relay outputs which can be used for simple process weighing.

The outputs also only work when the button corresponding to the icon  has been pressed.

Press the  button to enter the Main Menu.

With the button corresponding to the  icon, go down the list and highlight **Application Mode**. Enter this sub-menu by pressing the button corresponding to the  icon.

In the Application Mode menu enter the **Filling** sub-menu.

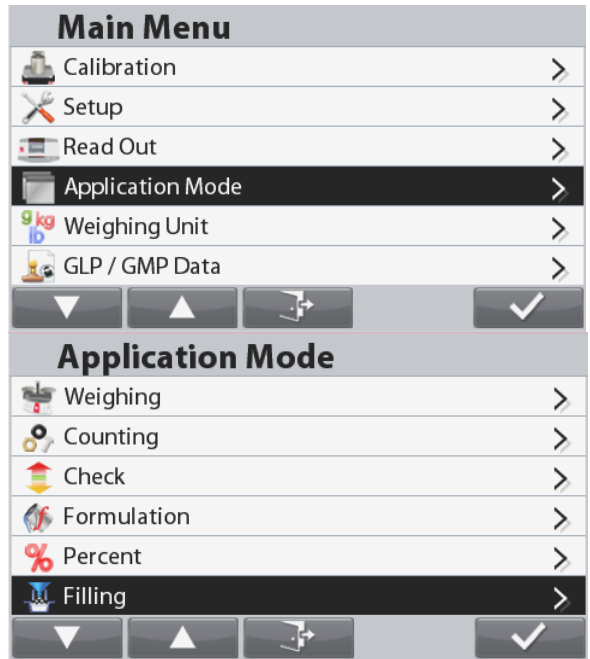

The Filling sub-menu is now displayed. Select the list item and press the button corresponding to the  icon to change the setting as desired.

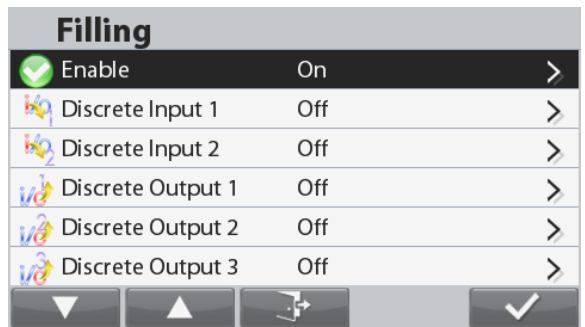

4.7 Dynamic Weighing

Use this application to weigh an unstable load, such as a moving animal. Three different start/reset modes can be selected: Manual (start and stop via key press), **Semi-Automatic** (auto-start with manual reset), and **Automatic** (start and stop automatically).

Press the  button until **Dynamic** is displayed in the upper left portion of the home screen.

Press the button corresponding to the icon  to start averaging.

To abort the averaging press the button corresponding to the icon .

When the averaging has finished, press the button corresponding to the icon  to reset.



The **DYNAMIC** Home screen

Main Display Line

Reference Fields
Functions



Application Icon

Note: Refer section 9.5, or press the  button for button icon explanation.

4.7.1 Application Setup

The Application can be customized for various user preferences.

Press the button corresponding to the  icon to enter **Application Setup**.



The **Configuration Menu** is now displayed.

Select the list item and press the button corresponding to , to change the setting as desired.

To return to the Application home screen, press the button corresponding to .

Configuration	
Dynamic Mode	Manual
Auto Tare	Off
Chain Tare	On
Accumulate	Off
	

The Dynamic Configurations are defined below (defaults in **Bold**).

Item	Available Settings	Comments
Dynamic Mode	Manual , Semi-Automatic, Automatic	To set the Mode
Auto Tare	On, Off	To enable Automatic Tare
Chain Tare	On , Off	To enable Chain (Continuous) Tare
Accumulate	Off , Automatic, Manual	To enable Accumulate / Totalization

4.7.2 Average Time Setup

Press the button corresponding to the  icon to enter the **Edit Average Time** screen.



The **Edit Average Time** screen is now displayed.

Enter the Average Time by using the alphanumerical keypad and press the button

corresponding to the  icon to change save the value and return to the Application home screen.

The default Average Time is 10 s.

Note: When the time is set to 0, the first stable weight over 5d will be displayed.

Averaging time can be set to a value between 0 and 60.





4.7.3 Input/Output (I/O) Setup

The I/O's can be customized for various user preferences. The I/O's are defined below (defaults in **Bold**).

Item	Available Settings
Discrete Input 1	Off , Zero, Tare, Clear Tare, Print, Start, Reset, Accumulate
Discrete Input 2	Off , Zero, Tare, Clear Tare, Print, Start, Reset, Accumulate
Discrete Output 1	Off , Underload, Overload
Discrete Output 2	Off , Underload, Overload
Discrete Output 3	Off , Underload, Overload
Discrete Output 4	Off , Underload, Overload

Note: The I/O's will only work when the I/O Option Board have been installed. See the Accessory list in section 9.4 for information. The option I/O board provides two isolated inputs and four dry-contact normally open relay outputs which can be used for simple process weighing.

Press the  button to enter the Main Menu.

With the button corresponding to the  icon, go down the list and highlight **Application Mode**. Enter this sub-menu by pressing the button corresponding to the  icon.

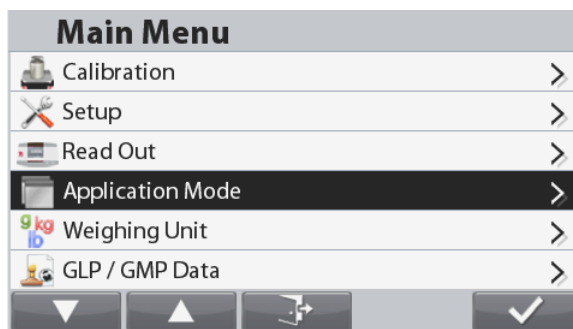

In the Application Mode menu enter the **Dynamic** sub-menu.

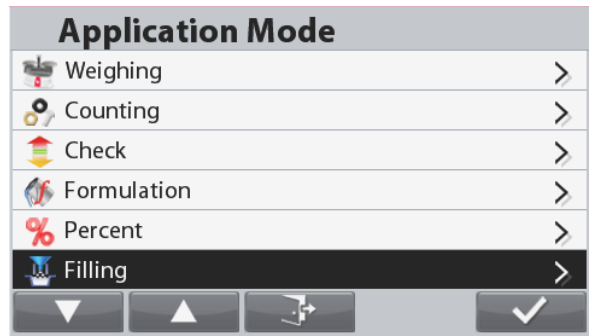

The Dynamic sub-menu is now displayed. Select the list item and press the button corresponding to the  icon to change the setting as desired.

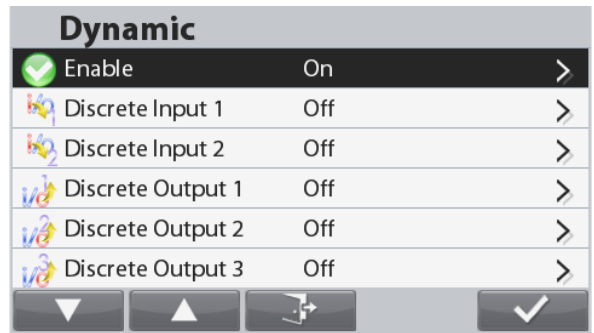

4.8 Density Determination

The Ranger 7000 can be used to determine an object's density. Two types of density determination can be made:

1. Solids *more* dense than water
2. Solids *less* dense than water

Press the  button until **Density** is displayed in the upper left portion of the home screen.

Before making density measurements, establish the Application Settings.

Press the button corresponding to the icon  to start.

Check the object weight in air and when prompted press the button corresponding to the icon .

Check the object weight again when it is submerged in the liquid and when prompted press the button corresponding to the icon . The density of the object will be displayed.



The **DENSITY** Home screen

Main Display Line

Reference Fields
Functions



Application Icon

Notes:

Refer section 9.5, or press the  button for button icon explanation.

4.8.1 Application Setup

The Application can be customized for various user preferences.

Press the button corresponding to the  icon to enter **Configuration**.



The **Configuration Menu** is now displayed.

Select the list item and press the button corresponding to , to change the setting as desired.

To return to the Application home screen, press the button corresponding to .

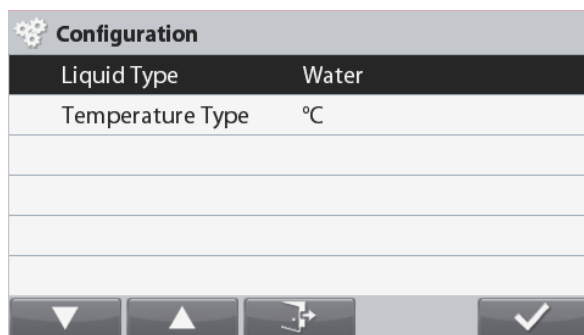

The **Density Determination Configurations** are defined below (defaults in **Bold**).

Item	Available Settings	Comments
Liquid Type	Water , Other*	To set the Liquid type
Temperature Type	°C , °F	To set the Temperature Type

Note: * Other liquids that are not water.

4.8.2 Water Temperature / Liquid Density Setup

To set the water temperature or Liquid density (other liquids than water), please follow the instructions below.

Liquid type: Water

Press the button corresponding to the  icon to enter the **Enter Water Temperature** screen.



The **Enter Water Temperature** screen is now displayed.

Enter the water temperature by using the alphanumerical keypad and press the button

corresponding to the  icon, to save the value and return to the previous screen.

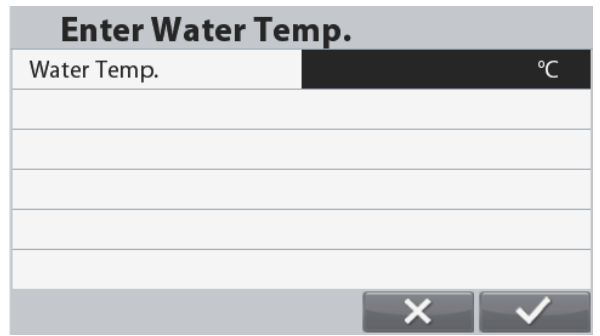

Liquid Type: Other

Press the button corresponding to the  icon to enter the **Enter Liquid Density** screen.



The **Enter Liquid Density** screen is now displayed.

Enter the liquid density by using the alphanumerical keypad and press the button corresponding to the  icon, to save the value and return to the previous screen.

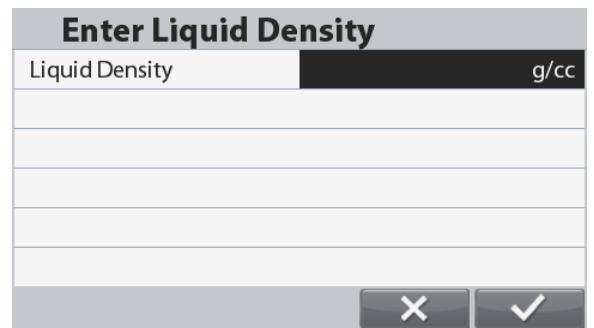

4.9 Differential Weighing

Differential weighing stores weight values of the samples. The samples can then be dried or processed and the difference in weight calculated. Up to 20 samples can be stored.

Press the  Button until **Differential** is displayed in the upper left portion of the home screen.

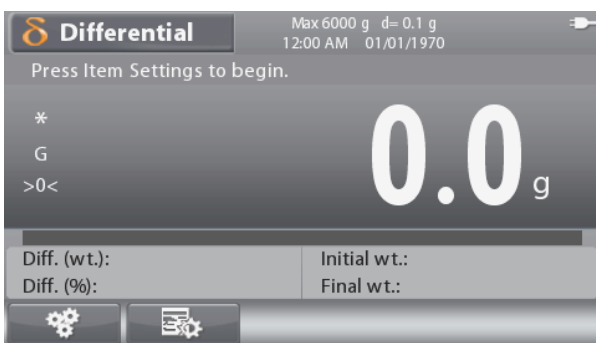

The **DIFFERENTIAL** Home screen

Main Display Line

Reference Fields
Functions



Application Icon

Note: Refer section 9.5, or press the  button for button icon explanation.

4.9.1 Application Setup

The Application can be customized for various user preferences.

Press the button corresponding to the  icon to enter **Configuration**.

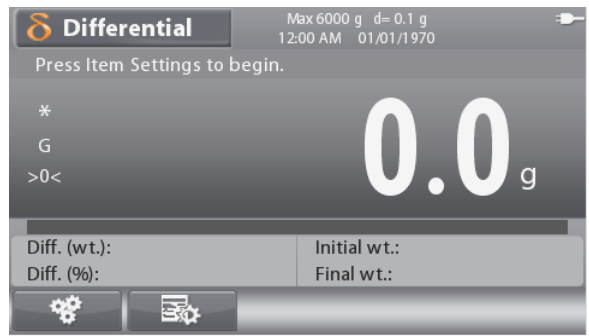

The **Configuration Menu** is now displayed.

Select the list item and press the button corresponding to , to change the setting as desired.

To return to the Application home screen, press the button corresponding to .



The **Differential Configurations** are defined below (defaults in **Bold**).

Item	Available Settings	Comments
Auto Tare	Off , On	To set the Automatic Tare
Chain Tare	On , Off	To set the Chain Tare

4.9.2 Differential Operation

To start differential, please follow the instructions below.

Press the button corresponding to the  icon to enter **Edit Item**.

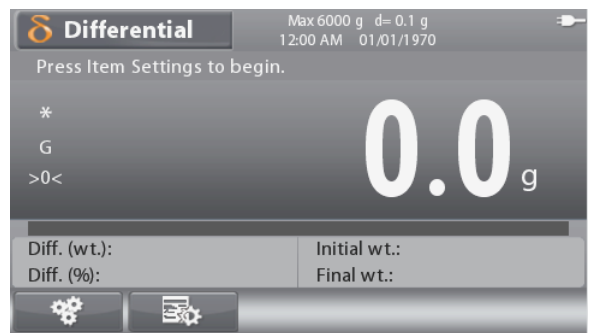

The **Edit Item Menu** is now displayed

Press  to add a new item. A maximum of 20 items can be created.

Press , the current item is selected and the scale returns to the main screen to start differential weighing.

Press  to edit the name and values of the item.

Note: All data will automatically be cleared when scale is powered Off.
An item must be selected to start differential operation.

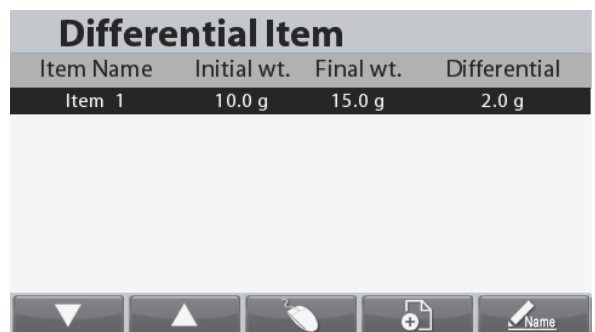

4.10 Library

When an item is processed on a regular basis, the item’s data may be stored in memory for future use. This memory is referred to as the Scale’s Library.

The following data is stored for the Application used:

Application	PN (Part Number)	Name	Preset Tare	APW	Ref./Target Weight	Check Limits	SP Set Points	Max Records
Weighing	x	x	x					300
Counting	x	x	x	x				300
Percent	N/A							x
Check	x	x	x	x		x		300
Dynamic	N/A							x
Filling	x	x	x		x		x	300
Formulation	x	x	x		x			30
Differential	N/A							x
Density	N/A							x

Notes: Maximum length of PN and Name is 30 characters.
For the formulation library, each record can store up to 100 components.

4.10.1 Creating a Library Record

To create a Library record, press the Library button . The requested data records will appear according to the active application mode (see section 4.10 above). In this example the Weighing Library screen is now displayed.





To return to the previous screen press the Library button  again.

To add a Library record, press the button corresponding to the icon .

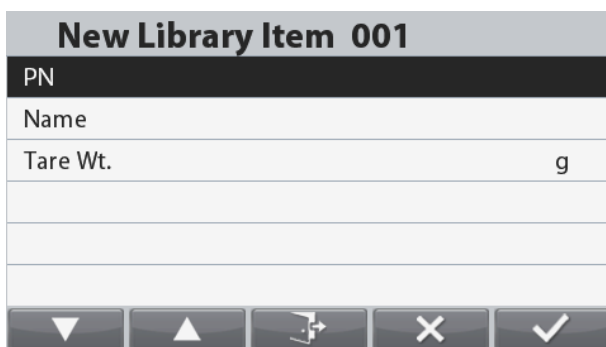
The New Library Item screen is displayed



Press the button corresponding to the icon  to enter PN by using the alphanumeric keypad.

Press the button corresponding to the icon  again to save the Barcode.

Repeat the process to enter Name, Tare Weight and other values by using the button corresponding to  to move down in the list.

Note: Library Names can be 8 characters or less.

Press the button corresponding to the  icon to go back to Library List screen.

4.10.2 Retrieving a Library Record

To load a Library record from the home screen

press the  button.

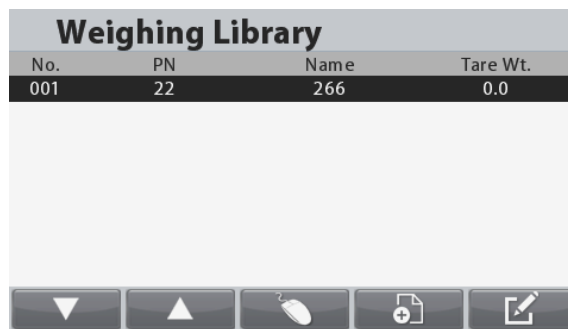

The Weighing Library screen is now displayed.

Then press the button corresponding to the icon  to load the Library data and return to the Application mode related to the Library record.



4.10.3 Editing a Stored Library Record

To delete a stored record, follow “Retrieving a Library Record” above.

Use the buttons corresponding to the icons  and  to move up and down in the list and highlight the Library item to be edited.

Then press the button corresponding to the icon .

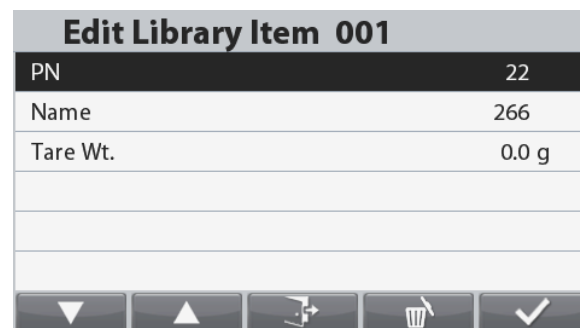

The Edit Library Item screen will be displayed. Make the necessary changes and the press the button corresponding to the icon  to return to the Library List.



4.10.4 Deleting a Stored Library Record

To delete a stored record, follow “Editing a Stored Library Record” above.

Press the button corresponding to the icon . A new screen will be displayed asking for confirmation.

Press the button corresponding to the icon  to delete the record, or press the button corresponding to the icon  to go back to the previous screen.

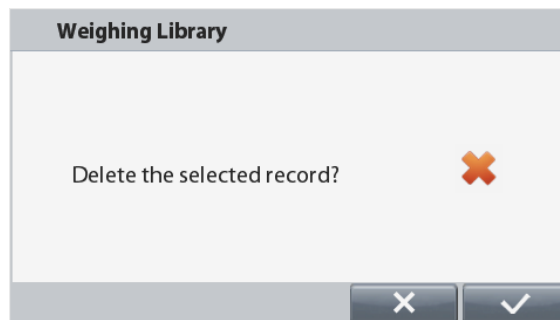

4.11 Additional Features

4.11.1 Weigh Below

The Ranger 7000 Scale is equipped with a weigh below hook for weighing below the scale.



CAUTION: Make sure that the scale is properly supported so that it cannot fall or detach during use of the Weigh below feature. Failure to follow these instructions could result in personal injury and damage to the equipment.

To use this feature, remove power from the scale, then remove the protective cover for the weigh below opening (2 screws). The protective cover is reversible for easy storage.



With Cover



Without Cover

The scale can be supported using lab jacks or any other convenient method. Ensure the scale is level and secure. Power on the Scale, then use an appropriate string or wire to attach items to be weighed.

5. MENU SETTINGS

5.1 Menu Navigation

To enter the Main Menu, press the  button from any Application Home screen.

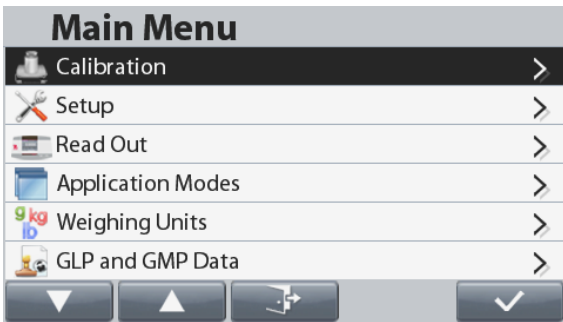

Changing Settings

To change a menu setting, navigate to that setting using the following steps:

Enter the Menu

From any Application screen, press the  button.

The Main Menu List appears on the display.

Select the Sub-Menu

Scroll to the desired Sub-menu in the Main Menu List by using the button corresponding to the icon



. Press the button corresponding to the icon



to display the Sub-menu items.

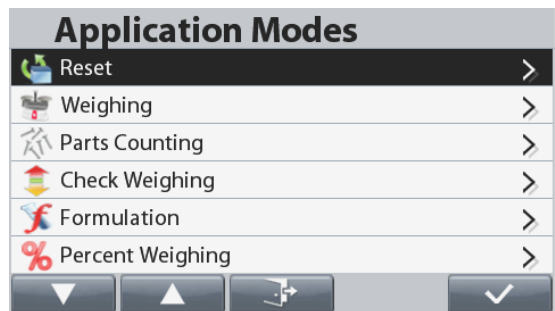

Select the Sub-Menu Item

Scroll to the desired Sub-menu Item using the button corresponding to the icon .



Press the button corresponding to the icon  to view the Sub-menu item's settings.

Select the Setting.

Scroll to the desired Setting using the button corresponding to the icon .

Press the button corresponding to the icon  to select the setting.

Press the  button to return to the previous screen.

Press the  button or the button corresponding to the icon , to exit the menu mode and return to the last active Application mode.

5.2 Main Menu

The Main menu selections are illustrated below.

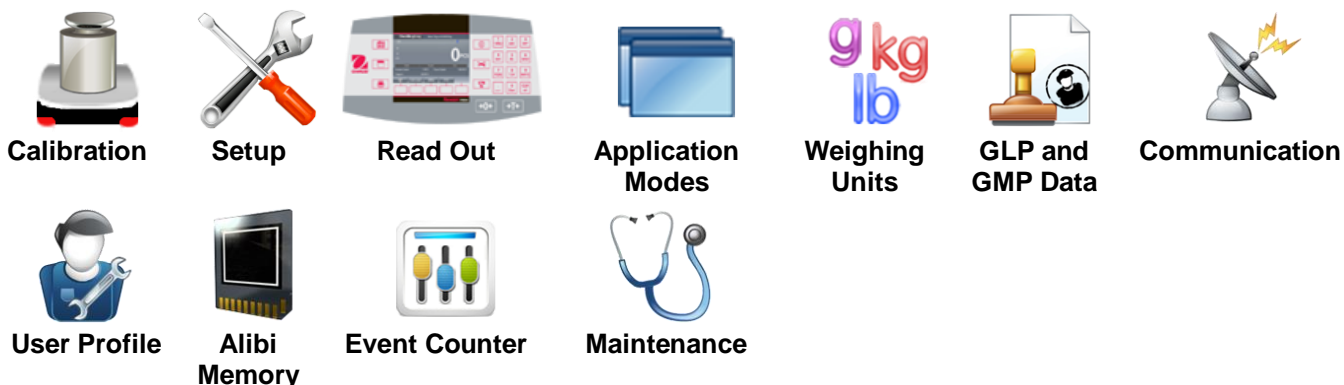

5.3 Calibration

R71MD models offer three calibration methods: Zero Calibration, Span Calibration and Linearity Calibration.

R71MHD models offer 5 calibration methods: Zero Calibration, Span Calibration, Linearity Calibration, Internal Calibration and Automatic Calibration.

Do not disturb the scale during any calibration.

5.3.1 Calibration sub-menu

R71MD models:



R71MHD models:



5.3.2 Zero Calibration

Use this calibration method to adjust the zero calibration point, without affecting the span or linearity calibration.

5.3.3 Span Calibration

Span calibration uses two calibration points, one at zero load and the other can be chosen by the user by using the numerical keypad.

With the scale turned ON and no load on the pan, start Span Calibration to initiate the procedure. Additional calibration values to be used are shown on the display. The best accuracy is achieved using the mass closest to the full span value.

5.3.4 Linearity Calibration

Linearity calibration uses three calibration points, one at zero load and the others at specified loads. Refer to Table 5.1 for Linearity values.

TABLE 5-1 Calibration Masses

Model	Linearity Calibration Points	Weight Class	
R71MHD3	0 kg, 1.5 kg, 3 kg	ASTM Class 2	OIML F1
R71MHD6	0 kg, 3 kg, 6 kg	ASTM Class 2	OIML F1
R71MHD15	0 kg, 10 kg, 15 kg	ASTM Class 2	OIML F1
R71MHD35	0 kg, 20 kg, 35 kg	ASTM Class 2	OIML F1
R71MD3	0 kg, 1.5 kg, 3 kg	ASTM Class 5	OIML M1
R71MD6	0 kg, 3 kg, 6 kg	ASTM Class 5	OIML M1
R71MD15	0 kg, 10 kg, 15 kg	ASTM Class 5	OIML M1
R71MD35	0 kg, 20 kg, 35 kg	ASTM Class 5	OIML M1

5.3.5 Internal Calibration (R71MHD models)

Calibration is accomplished with the internal calibration mass. Internal calibration can be performed at any time, provided the scale has warmed up to operating temperature and is level.

With the Scale turned ON and no load on the pan, select **Internal Calibration**.
The Scale begins to calibrate.

The display shows the status, then returns to the current application.

To cancel at any time, press .

5.3.6 Automatic Calibration (R71MHD models)

When **Automatic Calibration** is set ON, the scale performs a self-calibration:

- when it senses a temperature change of 1.5°C
- or every 11 hours

AutoCal will automatically calibrate the Scale (using the internal mass) each time there is a change in temperature significant enough to affect accuracy.

Note: * **Automatic Calibration function is only available in certain regions.**

5.3.7 GEO Adjustment

Enter this sub-menu to set the GEO values.

Press the button corresponding to the icon  to adjust the GEO value.

Choose the correct GEO value and press the button corresponding to the icon  to confirm.

The values range from 0-31.

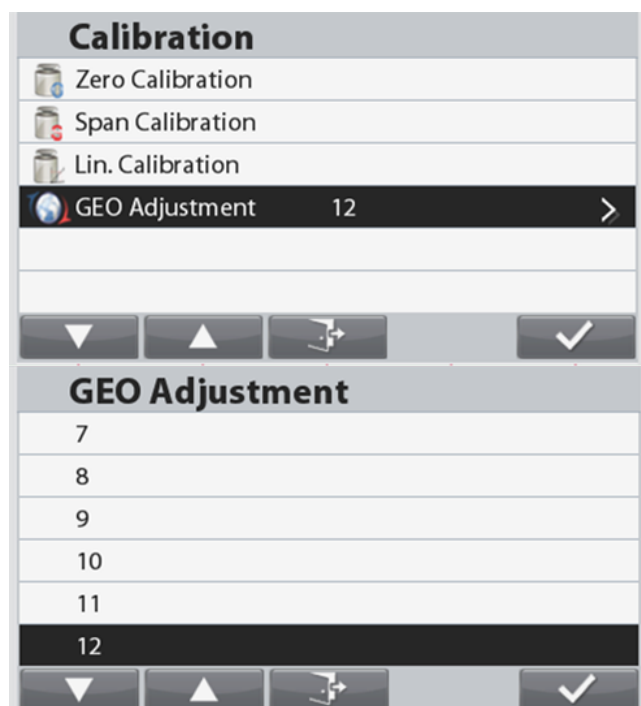

Note: GEO is only available in R71MD models. See table 9-3 for GEO values.

5.4 Setup

Enter this sub-menu to customize Scale display functionality.

5.4.1 Scale Setup sub-menu



Reset



Language



Power On Unit



Key Beep



X10Display



Barcode Rule

Factory default settings are shown below in bold.



5.4.2 Reset

Reset all settings to factory default settings.

= Reset.

= Do not reset and return to Setup menu screen.



5.4.3 Language

Set the language displayed for menus and displayed messages.

English

Spanish

German

French

Italian

Chinese



5.4.4 Power On Unit

Set the unit that will be displayed at Power On.

Auto

Kilogram

Pound

Gram

Ounce

Pound:Ounce



5.4.5 Key Beep

Set whether or not the beeper sounds when a button is pressed.

OFF = disabled.

ON = enabled.



5.4.6 X10 Display

Set the X10 Display. When ON, the display shows only one decimal point.

OFF = disabled.

ON = enabled.

Note: When the scale is used in Legal for Trade the setting will be forced to OFF and it will not be changeable.



5.4.7 Barcode Rule

The barcode rule validates a scanned barcode number. Two different rules can be set. If both rules are enabled, any barcode that match either rule 1 or rule 2 will be accepted by the scale.

Match Rule 1
OFF = disabled.
 ON = enabled.

Match Rule 2
OFF = disabled.
 ON = enabled.

Example 1:

Barcode Rule		
Match Rule1	On	>
Rule1	
Match Rule2	Off	>
<div style="display: flex; justify-content: space-between; align-items: center;"> ▼ ▲ ↻ ✓ </div>		

In this example the barcode rule is set to '.....'. This means that any barcode that is 8 characters long will be accepted by the scale, regardless of what the individual characters are.

Example 2:

Barcode Rule		
Match Rule1	On	>
Rule155	
Match Rule2	Off	>
<div style="display: flex; justify-content: space-between; align-items: center;"> ✕ ✓ </div>		

In this example the barcode rule is set to '....55'. This means that any barcode that is 7 characters long and ending with the numbers '55' will be accepted by the scale.

Note: The barcode rule is only functional when connecting a barcode scanner through the USB host. Please refer to the barcode scanner manual for supported barcode types.

The barcode will be stored as PN (Part Number) in the library. The maximum length of the barcode (PN) is 30 characters.

5.5 Read Out

Enter this sub-menu to customize Scale display functionality.

Scale Read Out sub-menu



Reset



Stability



Zero Range



Filter Level



Auto Zero Tracking



Brightness



Auto Dim (minutes)



Auto Sleep (minutes)

Factory default settings are shown below in bold.



5.5.1 Reset

Reset all settings to factory default settings.

Yes = Reset.

No = Do not reset and return to Read Out menu screen.



5.5.2 Stability

Set the amount the reading can vary while the stability symbol remains on.

0.5 Division = 0.5 graduations

1 Division = 1 graduation

2 Division = 2 graduations

5 Division = 5 graduations

Note: The setting is forced and locked to 1 Division when the Security Switch is set to the locked position.



5.5.3 Zero Range

Set the percentage of scale capacity that may be zeroed.

2%

10%

Note: The setting is forced and locked to 2% when the Security Switch is set to the locked position.



5.5.4 Filter level

Set the amount of signal filtering.

LOW = faster stabilization time with less stability.

MEDIUM = normal stabilization time with normal stability.

HIGH = slower stabilization time with more stability.

Note: The setting is at the current setting when the Security Switch is set to the locked position.



5.5.5 Auto Zero Tracking

Set the automatic zero tracking functionality.

- OFF = disabled.
- 0.5 Division** = display maintains zero up to a drift of 0.5 graduation per second
- 1 Division = display maintains zero up to a drift of 1 graduation per second.
- 3 Division = display maintains zero up to a drift of 3 graduations per second.

Note: The setting is forced and locked to 0.5 Division when the Security Switch is set to the locked position.



5.5.6 Brightness

Set the display brightness using the numerical keypad.

20...**80**...100



5.5.7 Auto Dim (minutes)

Set whether the display dims after x seconds/minutes.

- OFF = disabled.
- 1...30 (minutes)



5.5.8 Auto Sleep (minutes)

Set whether the display enters sleep mode after x seconds/minutes.

- OFF = disabled.
- 1...100 (minutes)



5.6 Application Mode

Enter this sub-menu to enable or disable the desired Scale Applications. Only one application can be running at a time.

Note: The use of each Application is described in detail in Section 4.

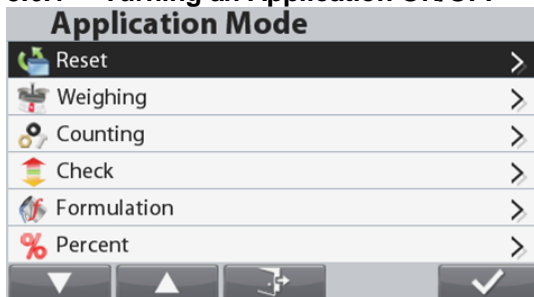
5.6.1 Turning an Application ON/OFF



Highlight the application by pressing the buttons   corresponding to the icons and then press the button corresponding to the icon  to enter the selected submenu.

In the Item option screen, enter the **Enabled** menu to turn it on or off.

Once an Application is enabled (turned on) it may be chosen by pressing the **Applications** button until it's icon appears in the upper left corner of the home screen. The current menu item status is shown: OFF = disabled, **ON** = enabled

5.7 Weighing Units

Enter this sub-menu to activate the desired units of measure.

Note: Due to national laws, the scale may not include some of the units of measure listed.

5.7.1 Units Sub-menu



Notes: The setting is locked when the Security Switch is set to the locked position.

5.7.2 Reset

To reset the unit settings to factory default settings select Reset and then confirm either Yes or No.

5.7.3 Turning a Unit ON/OFF

Select the desired unit, then press the button corresponding to the icon and then choose either On or Off.

The current menu item status is shown.

- OFF = disabled
- ON = enabled

Weighing Units		
	Reset	>
	Kilogram	On >
	Pound	On >
	Gram	On >
	Ounce	On >
	Lb:Oz	On >

5.8 GLP and GMP Data

Enter this menu to set the Good Laboratory Practices (GLP) and Good Manufacturing Practice data.



GLP Data Sub-menu



5.8.1 Reset

Resets the settings to factory default settings. Reset the settings to factory default settings.



5.8.2 Date Format

Set the scale date format.

- MMDDYYYY = Month Day Year (default)
- DDMMYYYY = Day Month Year
- YYYYMMDD = Year Month Day



5.8.3 Date

Set the current date using the alphanumeric keypad.



5.8.4 Time Format

Set the scale time format.

- 24H = 24 hour format (default)
- 12H = 12 hour format



5.8.5 Time

Set the current time.



5.8.6 Project ID

Set the project ID by using the alphanumeric keypad.

5.9 Communication

Enter this menu to define external communication methods and to set printing parameters. Data may be output to either a printer or PC (see section 6.5 for output string). Factory default settings are shown in bold.

Communication Sub-menu



RS232



USB

Choosing an item brings up another menu level (RS232 shown):



Configuration



Print Setup

Choosing an item brings up yet another menu level, the device settings are dependent on the COM chosen (RS232 shown)

Configuration Menu: (RS232 shown)



5.9.1 Reset

Resets the settings to factory default settings. Reset the settings to factory default settings.



5.9.2 Baud Rate

Set the baud rate (bits per second).

300
600
1200
2400
4800
9600
19200



5.9.3 Parity

Set the data bits and parity.

7 EVEN = 7 data bits, even parity
7 ODD = 7 data bits, odd parity
7 NONE = 7 data bits, no parity
8 NONE = 8 data bits, no parity



5.9.4 Stop Bits

Set the stop bits.

1 BIT
2 BIT



5.9.5 Handshake

Set the flow control method.

- NONE** = no handshaking
XON/XOFF = XON/XOFF handshaking
HARDWARE = hardware handshaking (COM1 menu only)



5.9.6 Alternate Command

Enter this sub-menu to set a different command character for the P (Print), T(Tare) or Z(Zero)

Alternate Print Command

Set the alternate command character for Print.

Settings of A(a) to Z(z) are available, except T&Z. The default setting is **P**.

Alternate Tare Command

Set the alternate command character for Tare.

Settings of A(a) to Z(z) are available, except P&Z. The default setting is **T**.

Alternate Zero Command

Set the alternate command character for Zero.

Settings of A(a) to Z(z) are available, except P&T. The default setting is **Z**.

Print Setup Menu: (RS232 shown)



5.9.7 Reset

Resets the settings to factory default settings. Reset the settings to factory default settings.



5.9.8 Stable Weight Only

Set the printing criteria.

- OFF** = values are printed immediately, regardless of stability.
ON = values are printed only when the stability criteria are met.



5.9.9 Auto Print

Set the automatic printing functionality

- OFF** = disabled
ON STABLE = printing occurs each time the stability criteria are met.
INTERVAL = printing occurs at the defined time interval.
CONTINUOUS = printing occurs continuously.

When ON STABLE is selected, set the time interval using the numeric keypad.

- LOAD** = prints when the displayed load is stable
LOAD ZERO = prints when the displayed load or zero reading is stable.

When INTERVAL is selected, set the time interval using the numeric keypad.

Settings of 1 to 3600 seconds are available.

Note: Pressing the print button when INTERVAL has been selected will print the displayed result immediately.



5.9.10 Print Template

This sub-menu is used to define the format of the data output to a printer or computer.

Simple = only prints result and unit

Standard = prints result, tare, mode, unit, GMP, PN, Lib, ID, name

Custom 1 = customized printout format. If not customized, Simple template will be used

Custom 2 = customized printout format. If not customized, Simple template will be used

Custom 3 = customized printout format. If not customized, Simple template will be used

Custom 4 = customized printout format. If not customized, Simple template will be used

Custom 5 = customized printout format. If not customized, Simple template will be used

Example (Standard Template):



5.9.11 Edit Template

This sub-menu is used to edit the Print templates.

Note: Only the Custom templates can be edited.

Simple

Standard

Custom1

Custom2

Custom3

Custom4

Custom5

Each item in the content on the left side can be switched On/Off. The right side will show all the enabled items.

The content for the templates includes:

Header (5 header lines) , User ID, Project ID, Scale No., Date & Time, PN, Result, Gross, Net, Tare, Mode, Unit, Info (i.e. reference weight, check limits), Accu, Library ID, Library Name, Alibi Record(6 digits, i.e. 000235), Footer (2 footer lines).

The item Header, Footer, Date/Time, User ID, Project ID and Scale NO have selections “Off, Single, Continuous”. Single means that the related item will be printed out only one time after power on or the related menu setting changed. Continuous means that the related item will be printed out at each print out.

The item Accumulation has selections “Off, Result, All”. Result means that only the total weight/PCS will be printed out. All means that all the accumulated information as well as statistical information will be printed out.

See section 6.6 for sample printouts.



5.9.12 Line Feed

Set the paper feed

1 Line = move the paper up one line after printing.

4 Line = move the paper up four lines after printing.

FORM = a form feed is appended to the output.



5.9.13 Data Transfer

Output weighing results directly to a PC application. Setup is easy and no additional software is required.

Note: Data Transfer Function is not supported in Windows® 7. OHAUS provides SPDC software for Windows 7 users. Please download from below link:

- OFF** = do not print.
- ON** = print the specified settings.

Click the Start Menu in Windows XP system and click “Settings” →open **Control Panel**.

Double click **Accessibility Options** in Control Panel.



Select the **General** tab in Accessibility Options.

Check **Use Serial Keys**, and click the **Settings** button.

Select the **Serial Port**, and set the **Baud rate** to **9600**.



After selecting, click **OK** to close setting for serial keys. Close the Control Panel.

Run Excel® to open one blank sheet. Click on the cell where the data is to be placed. At this time, if the scale sends data to the PC through the RS232 port, the data will be put into the cell, and the cursor will automatically move to the next vertical cell.

Note: If the weighing value is a negative number, set the target cell in TEXT format. Otherwise, Excel will not distinguish it as a negative number.

5.10 User Profiles

Create users with user name and password.

User Screen

User Profiles		
No.	User	Authority
01	668	Aministrator

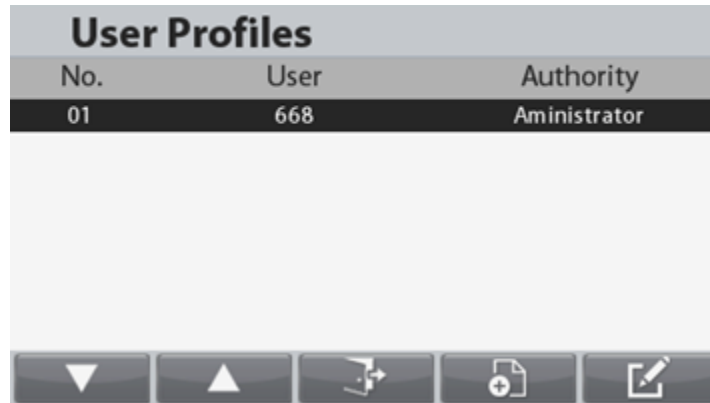

Functions

1. The User profile is used for saving user specific parameters in menu
2. Total 50 user profiles can be saved in file system
3. User name max length: 12
4. Password max length: 6

User authorities

1. User types
 - a) Administrator
 - b) Power user
 - c) Guest

Notes: Only one Administrator user
The first user is always Administrator
If no user have been created, login as Administrator.

Administrator Account:

Only the Administrator user can create, delete and edit other users and itself. If an administrator user is deleted, all the power users will also be deleted.

Power User Account:

The Power user can only modify the menu settings but cannot create, delete or edit other users or itself.

Guest Account:

Login as a Guest user will occur directly when pressing the button corresponding to the icon , no password is required.

The Guest user can view but cannot modify the general menu settings. All the menus are locked. The Guest user can modify the app configurations but cannot add/edit library records.

Login Screen

Long press the  button to start the User login screen to change the user. Login is also required during power up.

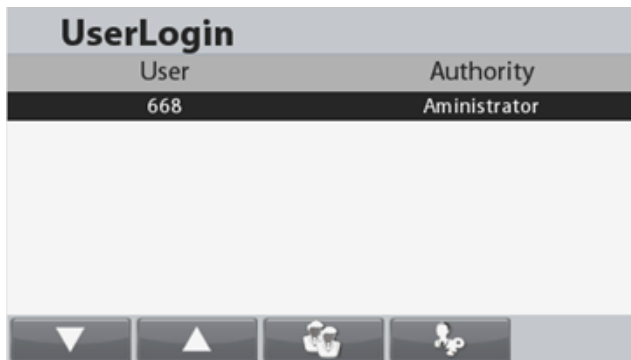

To login as Administrator press the button corresponding to the icon . A login screen is displayed with a password field. Enter the password associated with the account.

If the wrong password is entered, an error screen will be displayed. Press the button corresponding to the icon  to return to the login screen.

To login as guest press the button corresponding to the icon .

Note: if no user was created, no login is required and automatically login as administrator.

5.11 Alibi Memory

Note: This menu is only visible if the Alibi memory hardware option has been installed.

Alibi memory is used to store the weight history for reference. Each Alibi record contains a Record ID, Net Weight value, Tare value and Date & Time.

Enter the Check Records menu item to review the records.

Notes:

The maximum number of record is 262112. When the memory is full and another record is stored the first record will automatically be deleted. At this time a warning message will appear, asking for the user's confirmation.

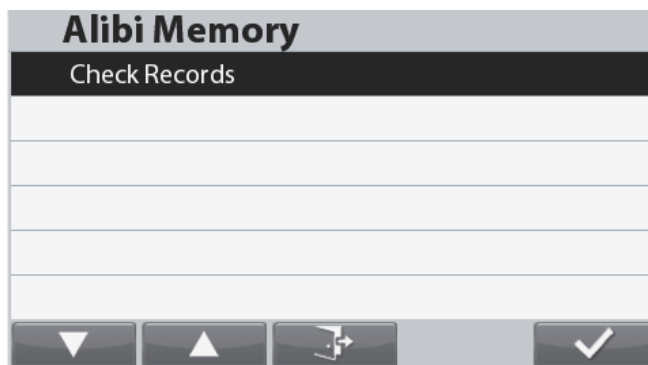

The latest record is always displayed on top. Use the buttons corresponding to the icons and to move up and down the list.

Press the button corresponding to the icon  to locate a record by entering it's ID No.

Press the button corresponding to the icon  to print a range of records.

Press the button corresponding to the icon  to return to previous menu.

Alibi Memory Records				
No.	Weight	Tare	Date/Time	Platform
1	1.10g	0.00g	01/01/2013 00:01	1
2	50g	34.5g	01/01/2013 00:05	1

Note: Only stable weight can be printed to the Alibi memory.

5.12 Event Counter

For jurisdictions that use the audit trail sealing method, the local weights and measures official or authorized service agent must record the current configuration and calibration event counter values at the time of sealing. These values will be compared to values found during a future inspection.

Note: A change to an event counter value is equivalent to breaking a physical seal.

The audit trail uses two event counters to record changes to configuration and calibration settings.

- The configuration event counter (CFG) will index by 1 when exiting the menu if one or more of the following menu settings are changed: Zero Range, Stable Range, Auto Zero Tracking (AZT), Units (kg, g, oz, lb or lb:oz) or Stable Only.
- The calibration event counter (CAL) will index by 1 when exiting the menu if a Span Calibration or GEO setting change is made. Note that the counter only indexes once, even if several settings are changed.

5.13 Maintenance



Export Library



Export User Profile



Import Library Drives



Import User Profile

Note: The import/export is only functional when the current user is administrator.

Maintenance Sub-menu



5.13.1 Export Library

Export Library to USB flash drive.



5.13.2 Export User Profile

Export User Profile to USB flash drive.



5.13.3 Import Library Drives

Import Library from USB flash drive.



5.13.4 Import User Profile

Import User Profile from USB flash drive.

Note: The existing users will be replaced when importing users.

6. SERIAL COMMUNICATION

6.1 Interface Commands

Commands listed in the following table will be acknowledged by the scale.

Command	Function
IP	Immediate Print of displayed weight (stable or unstable).
P	Print displayed weight (stable or unstable).
CP	Continuous
SP	Print on Stability.
xS	0S: Turn off "Stable Only" menu item and allow unstable print. 1S: Turn on "Stable Only" menu item and only print stable print.
xP	Interval Print x = Print Interval (1-3600 sec), 0P turns auto print OFF
Z	Same as pressing Zero Key.
T	Same as pressing Tare Key.
xT	Download Tare value in grams (positive values only). Sending 0T clears tare (if allowed).
PU	Print current unit: g, kg, lb, oz, lb:oz, t
xU	Set scale to unit x: 1=g, 2=kg, 3=lb, 4=oz, 5=lb:oz, 6=t
xM	Set scale to mode x. 1=Weighing, 2=Counting, 3=Check, 4=Formulation, 5=Percent, 6=Filling, 7=Dynamic, 8=Density, 9=Differential. M will scroll to next enabled mode.
PV	Version: print name, software revision and LFT ON (if LFT is set ON).
H x y "text"	Enter Header line, where x = print template number 1 to 5, y = line number 1 to 5, "text" = header text up to 40 alphanumeric characters
F x y "text"	Enter Footer line, where x = print template number 1 to 5, y = line number 1 to 2 "text" = footer text up to 40 alphanumeric characters.
\EscR	Global reset to reset all menu settings to the original factory defaults.
SNS x	Switch the platform: x = 1, 2
Notes:	The second commands listed are "legacy" commands, which maintain compatibility with older products.

6.2 RS232 Interface

RS232 (DB9) Pin Connections:

Pin 2: Scale transmit line (TxD)

Pin 3: Scale receive line (RxD)

Pin 5: Ground signal (GND)

Pin 7: Clear to send (hardware handshake) (CTS)

Pin 8: Request to send (hardware handshake) (RTS)

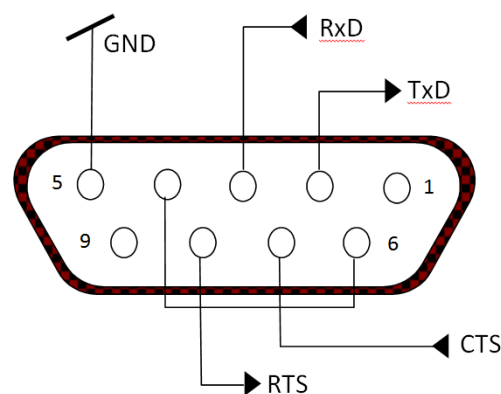

Use the built-in RS-232 Port to connect either to a computer or a printer.

6.2.1 Connecting to a Computer

Connect to the computer with a standard (straight-through) serial cable.

Use HyperTerminal or a similar terminal software to test communication with the computer.

Set up HyperTerminal as follows:

Choose New Connection, "connect using" COM1 (or available COM port).

Select Baud=9600; Parity=8 None; Stop=1; Handshaking=None. Click OK.

Choose Properties/Settings, then ASCII Setup. Check boxes as illustrated: (Send line ends...; Echo typed characters...; Wrap lines...)

Verify communication by pressing the Print button. If HyperTerminal is set up properly, the value on the display will be displayed in the window.

6.2.2 Connecting to a Serial Printer

Connect the cable supplied with the printer to the scale's RS-232 port.

Make sure that the balance and printer communication settings match.

Test communication with the printer by pressing the Print button. If the balance and printer are set up properly, the value on the display will be printed.

6.3 The USB Device Interface

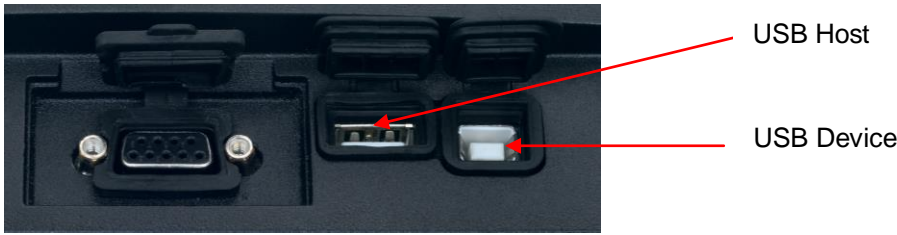

The Ohaus USB Device Interface is a unique solution to the problem of connecting a scale to a computer using a Universal Serial Bus (USB). USB devices are categorized into classes such as disk drives, digital cameras, printers, etc. Scales do not have a commonly used class so the Ohaus USB interface uses a generic interface based on the RS232 serial standard.

Data sent from the scale to a computer is in USB format. The USB data is directed to a *virtual port*. This port then appears as an RS232 port to the application program.

When sending a command from a computer to the scale, the application program sends a command to the *virtual port* as if it were an RS232 port. The computer then directs the command from the *virtual port* to the computer's USB connector where the scale is connected. The port receives the USB signal and reacts to the command.

The USB Interface includes a CD with the software drivers to create the required *virtual port* on the computer.

6.3.1 System Requirements

- PC running Windows 98, Windows 98SE, Windows ME, Windows 2000, Windows XP or Windows 7
- Available USB port (Type A, 4-pin, female)

6.3.2 USB Connection

The scale's USB port terminates with a 4-pin, female, USB Type B connector.

A USB Cable (type B/male to type A/male) is required (not supplied).

1. Ensure that the scale is powered on and working properly.
2. Power on the computer and verify that its USB port is enabled and working properly.
3. Plug the cable's USB connectors into the computer's USB port and the scale's USB port. Windows should detect a USB device and the New Hardware Wizard will be initialized.

6.3.3 Virtual Port Software Installation

1. Insert the supplied CD into the computer's CD drive.

Different versions of Windows have slightly different steps to load the driver that is on the CD. In all versions the New Hardware Wizard guides you through the required steps to select the driver that is located on the CD.

2. After clicking Finish, the virtual port should be ready for use.

Windows typically adds the virtual port in sequence after the highest number COM port. For example, on PC's equipped with up to 4 COM ports, the virtual port will be COM5.

When using the USB interface with programs that limit the number of COM port designations (e.g. Ohaus MassTracker allows only COM1, 2, 3, & 4), it may be necessary to assign one of these port numbers to the new virtual port.



Example of Windows XP Hardware Wizard

This can be done in the Port Settings of the Device Manager utility, found in the Windows Control Panel.

6.4 USB Host

The USB Host can be used to connect a keyboard, barcode scanner and USB flash drive to the Ranger 7000.

6.5 Printout Format

Printout string for g, kg, lb, oz units:

Field	Weight	Space	Unit	Space	Stability	Space	G/N	Space	Message	Term.Char(s)
Length	9	1	3	1	1	1	1	1	5	2

- The printout string has a fixed length of 23 characters.
- Each Space field is a delimiting space used to separate the other fields.
- The Weight field is 9 right justified characters. If the value is negative, the ' - ' character is printed at the immediate left of the most significant digit.
- The Unit/Mode field is 3 left justified characters.
- The Stability field is 1 character.
- The G/N field is 1 character. 'G' is printed for a gross weight. 'N' is printed for a net weight.
- The Message field is 5 left justified characters.

Note: The Termination Characters Carriage Return and Line Feed are appended to the printout.

Printout string for the lb:oz unit

Field	Weight1	Space	Unit1	Space	Weight2	Space	Unit2	Space	Stability	Space	G/N	Space	Message	Term.Char(s)
Length	4	1	2	1	7	1	2	1	1	1	1	1	5	2

- The printout string has a fixed length of 28 characters.
- Each Space field is a delimiting space used to separate the other fields.
- The Weight1 field is 4 right justified characters. If the value is negative, the ' - ' character is located at the immediate left of the most significant digit.
- The Unit1 field is 2 left justified characters.
- The Weight2 field is 7 right justified characters.
- The Unit2 field is 2 left justified characters.
- The Stability field is 1 character. A space is printed if the weight value is stable. A '?' is printed if the weight value is not stable.
- The G/N field is 1 character. 'G' is printed for a gross weight. 'N' is printed for a net weight.
- The Message field is 5 left justified characters.

Note: The Termination Characters Carriage Return and Line Feed are appended to the printout.

6.6 Printout Examples

Weighing	Description	Enabled
Company Name	Header 1	✓
Address 1	Header 2	✓
Address 2	Header 3	✓
Address 3	Header 4	✓
Address 4	Header 5	✓
Scale ID: 123	User ID	
03:57 PM 09/11/2013	Project ID	
0.79300 kg N	Scale ID	✓
1.36275 kg G	Date & Time	✓
0.79300 kg N	PN	
0.56975 kg T	Result	✓
Mode: Weighing	Gross	✓
Signature_____	Net	✓
Verified by_____	Tare	✓
	Mode	✓
	Unit	✓
	Information	
	Accumulate	
	Library ID	
	Library Name	
	Alibi Record	
	Footer 1	✓
	Footer 2	✓

Parts Counting	Description	Enabled
Company Name	Header 1	✓
Address 1	Header 2	✓
Address 2	Header 3	✓
Address 3	Header 4	✓
Address 4	Header 5	✓
Scale ID: 123	User ID	
03:58 PM 09/11/2013	Project ID	
PN: 80251234	Scale ID	✓
1125 PCS N	Date & Time	✓
2725 PCS G	PN	✓
1125 PCS N	Result	✓
0.56975 kg T	Gross	✓
Mode: Counting	Net	✓
APW: 0.356094 g	Tare	✓
Library ID: 1	Mode	✓
Library Name: Screw	Unit	✓
Signature_____	Information	✓
Verified by_____	Accumulate	
	Library ID	✓
	Library Name	✓
	Alibi Record	
	Footer 1	✓
	Footer 2	✓

Filling	Description	Enabled
Company Name	Header 1	✓
Address 1	Header 2	✓
Address 2	Header 3	✓
Address 3	Header 4	✓
Address 4	Header 5	✓
User ID: USER1	User ID	✓
Project ID: P123	Project ID	✓
1793.00 g N	Scale ID	
Mode: Filling	Date & Time	
Target: 1800.00 g	PN	
SP1: 1700.00 g	Result	✓
SP2: 1790.00 g	Gross	
	Net	
	Tare	
	Mode	✓
	Unit	✓
	Information	✓
	Accumulate	
	Library ID	
	Library Name	
	Alibi Record	
	Footer 1	
	Footer 2	

Density	Description	Enabled
Company Name	Header 1	✓
Address 1	Header 2	✓
Address 2	Header 3	✓
Address 3	Header 4	✓
Address 4	Header 5	✓
User ID: USER1	User ID	✓
Project ID: P125	Project ID	✓
Scale ID: S21	Scale ID	✓
04:58 PM 09/11/2013	Date & Time	✓
18.058 g/cm3	PN	
Mode: Density	Result	✓
Weight in air: 1001.70 g	Gross	
Weight in liquid: 946.35 g	Net	
Auxiliary liquid: Water	Tare	
Water Temp.: 20.0 °C	Mode	✓
Liquid Density: 0.9982 g/cm3	Unit	✓
	Information	✓
	Accumulate	
	Library ID	
	Library Name	
	Alibi Record	
	Footer 1	
	Footer 2	

Formulation (Recipe)

Item: 001

PN: 1234

Name: Egg

Formu.Wt: 100.00 g

Actual Wt: 99.60 g

Item: 002

PN: 1235

Name: Water

Formu.Wt: 500.00 g

Actual Wt: 497.95 g

Item: 003

PN: 1236

Name: Sugar

Formu.Wt: 120.00 g

Actual Wt: 124.10 g

Item: 004

PN: 1237

Name: Salt

Formu.Wt: 80.00 g

Actual Wt: 80.85 g

7. LEGAL FOR TRADE

When the scale is used in trade or a legally controlled application it must be set up, verified and sealed in accordance with local weights and measures regulations. It is the responsibility of the purchaser to ensure that all pertinent legal requirements are met.

7.1 Settings

Before verification and sealing, perform the following steps in order:

1. Verify that the menu settings meet the local weights and measures regulations.
2. Units menu should be reviewed. Verify the units turned on meet the local weights and measures regulations.
3. Perform a calibration as explained in Section 5.
3. Set the position of the Security Switch to the locked position.

7.2 Verification

A weights and measures official or authorized service agent must perform the verification procedure.

7.3 Sealing

After the scale has been verified, it must be sealed to prevent undetected access to the legally controlled settings. Before sealing the device, ensure that the security switch is in the Locked position and the Legal for Trade setting in the scale Setup menu has been set to ON.

If using a wire seal, pass the sealing wire through the holes in the security screw and tab, as shown.

If using a paper seal, place the seal over the flat head screw as shown

A. Base



Un-Locked



Locked with Wire Seal



Locked with Paper Seal

B. Terminal



Un-locked



Locked with Wire Seal



Locked with Paper Seal

Note: The Terminal only needs to be sealed if a second scale is attached to the optional 2nd A/D board.

8. MAINTENANCE

8.1 Calibration

Periodically verify calibration by placing an accurate weight on the scale and viewing the result. If calibration is required, perform as explained in section 5.



8.2 Information

Information is available from any application and is accessed by pressing the  button.



The following data is available for the Application used:

Application	Statistics	Accumulation	General Status	Help	Icons Explanation
Weighing	X	X	X	X	X
Counting		X	X	X	X
Percent		X	X	X	X
Check		X	X	X	X
Dynamic		X	X	X	X
Filling		X	X	X	X
Formulation			X	X	X
Differential			X	X	X
Density			X	X	X
Menu/Others				X	

Press the  button to enter the **Information** area.

Use the buttons corresponding to the icons  and  to toggle through the various Information screens.

Note: To return to Application Home screen from the Information area, press the  button.

To clear data, use the buttons corresponding to the icons  and  to select the item to be cleared, then press the  button.

A warning message appears, press the button corresponding to the  icon to confirm the deletion.

To abort the deletion press the button corresponding to the icon .

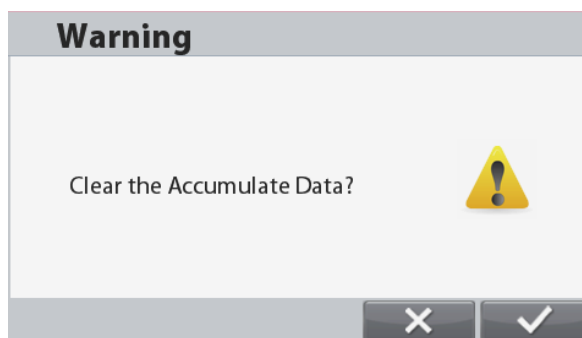
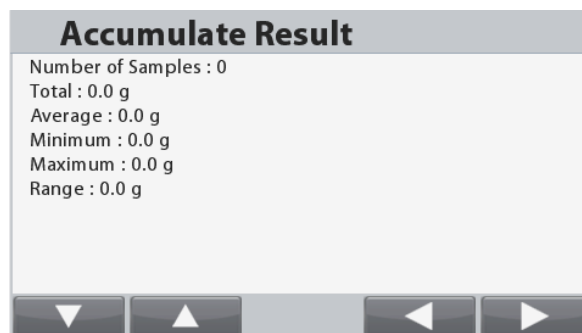

8.3 Cleaning



Disconnect the Ranger 7000 Scale from the power supply before cleaning. Make sure that no liquid enters the interior of the Terminal or Base.

Clean the Scale at regular intervals.

Housing surfaces may be cleaned with a lint-free cloth slightly dampened with water or a mild cleaning agent.

Attention: Do not use solvents, harsh chemicals, ammonia or abrasive cleaning agents.

8.4 Troubleshooting

TABLE 8-1. TROUBLESHOOTING

Error Code	Description	Cause
EEP Error	EEPROM Checksum Error	Corrupted EEPROM data
Power on Overload	Power On Error	Weight reading exceeds Power On Zero limit.
Power on Underload	Power On Error	Weight reading below Power On Zero limit.
Overload	Over Range Error	Weight reading exceeds Overload limit.
Underload	Under Range Error	Weight reading below Underload limit.
Tare Error	Tare out of range Error	Tared at one unit but after switching to another unit the tare value exceeds the maximum.
Display Overflow	Display Overflow	Weight exceeds 6 digits.
No Calibration	Calibration data error	Calibration data does not exist.
-----	Busy message	Displayed during tare setting, zero setting, printing
--NO--	Action not allowed message	Function not executed.
Calibration Error	Calibration Error	Calibration value outside allowable limits
Low Reference	Low reference weight warning message	Average Piece Weight too small. (Warning)
Reference Error	Unacceptable reference weight message	Reference Weight too small. The weight on the pan is too small to define a valid reference weight.

8.5 Service Information

If the troubleshooting section does not resolve your problem, contact an Authorized Ohaus Service Agent. Please visit our website www.ohaus.com to locate the Ohaus office nearest you. An Ohaus Product Service Specialist will be available to assist you.

8.6 Software Updates

Ohaus is continuously improving its scale software. To obtain the latest release, please contact your Authorized Ohaus Dealer or Ohaus Corporation.

9. TECHNICAL DATA

9.1 Specifications

Ambient conditions

- Indoor use only
- Altitude: Up to 2000 m
- Specified Temperature range: 10 °C to 30 °C (R71MHD3/6/15/35 models)
-10 °C to 40 °C (R71MD3/6/15/35 models)
- Humidity: maximum relative humidity 80 % for temperatures up to 30 °C
decreasing linearly to 50 % relative humidity at 40 °C
- Mains supply voltage fluctuations: up to ±10 % of the nominal voltage
- Installation category II
- Pollution degree: 2
- Operability is assured at ambient temperatures between 5 °C to 40 °C.

Materials

- Base Housing; die-cast Aluminum, Painted
- Terminal housing: die-cast Aluminum, Painted
- Weighing Pan: 304 Stainless Steel

TABLE 9-1. SPECIFICATIONS

MODEL	R71MHD3	R71MHD6	R71MHD15	R71MHD35
Capacity	3000 g	6000 g	15000 g	35000 g
Readability d	0.01 g	0.02 g	0.1 g	0.1 g
Approved Readability e	0.1 g	0.2 g	1 g	1 g
Repeatability (std. dev.)	0.01 g	0.02 g	0.1 g	0.1 g
Linearity	± 0.02 g	± 0.04 g	± 0.2 g	± 0.2 g
Weighing units	gram, kilogram, ounce, pound, pound:ounce, tonne			
Applications	Weighing, Parts Counting, Percent Weighing, Check Weighing, Dynamic Weighing, Filling, Formulation, Differential Weighing, Density			
Stabilization time (typical)	Within 1 second			
Safe overload protection	150 % of Capacity			
Display	TFT Graphic LCD			
Display size	4.3 inch			
Backlight	White LED			
Communication	RS-232, USB			
Power supply	Power Input: 100-240 V~ 0.5 A 50/60 Hz			
Platform size	240 x 240 mm 9.4 x 9.4 inch		377 x 311 mm 14.8 x 12.2 inch	
Terminal Housing dimensions (W x D x H)	267 x 118 x 72 mm 10.5 x 4.6 x 2.8 inch			
Base Housing dimensions (W x D x H)	280 x 280 x 114 mm 11 x 11 x 4.5 inch		377 x 311 x 128 mm 14.9 x 12.2 x 5 inch	
Assembled dimensions (W x D x H)	280 x 420 x 114 mm 11 x 11 x 4.5 inch		377 x 467 x 128 mm 14.9 x 18.4 x 5 inch	
Net weight	7.2 kg / 16 lb		10.9 kg / 24 lb	
Shipping weight	9.2 kg / 20.3 lb		14.4 kg / 31.7 lb	
Shipping dimension	605 x 405 x 244 mm 23.8 x 15.9 x 9.6 inch		665 x 525 x 330 mm 26.2 x 20.7 x 13 inch	

TABLE 9-2. SPECIFICATIONS (continued)

MODEL	R71MD3	R71MD6	R71MD15	R71MD35
Capacity	3000 g	6000 g	15000 g	35000 g
Readability d	0.05 g	0.1 g	0.2 g	0.5 g
Approved Readability e	0.5 g	1 g	2 g	5 g
Repeatability (std. dev.)	0.05 g	0.1 g	0.2 g	0.5 g
Linearity	± 0.1 g	± 0.2 g	± 0.4 g	± 1 g
Weighing units	gram, kilogram, ounce, pound, pound:ounce, tonne			
Applications	Weighing, Parts Counting, Percent Weighing, Check Weighing, Dynamic Weighing, Filling, Formulation, Differential Weighing, Density			
Stabilization time (typical)	Within 1 second			
Safe overload capacity	150 % of Capacity			
Display	TFT Graphic LCD			
Display size	4.3 inch			
Backlight	White LED			
Communication	RS-232, USB			
Power supply	Power Input: 100-240 V~ 0.5 A 50/60 Hz			
Platform size	280 x 280 mm 11 x 11 inch	377 x 311 mm 14.8 x 12.2 inch		
Terminal Housing dimensions (W x D x H)	267 x 118 x 72 mm 10.5 x 4.6 x 2.8 inch			
Base Housing dimensions (W x D x H)	280 x 280 x 114 mm 9.4 x 9.4 x 4.5 inch	377 x 311 x 128 mm 14.9 x 12.2 x 5 inch		
Assembled dimensions (W x D x H)	240 x 420 x 114 mm 17.4 x 16.5 x 4.5 inch	377 x 467 x 128 mm 14.9 x 18.4 x 5 inch		
Net weight	6.8 kg / 15 lb		9.9 kg / 21.8 lb	
Shipping weight	8.5 kg / 18.7 lb		13.4 kg / 29.5 lb	
Shipping dimensions	605 x 405 x 244 mm 23.8 x 15.9 x 9.6 inch	665 x 525 x 330 mm 26.2 x 20.7 x 13 inch		

9.2 Drawings and Dimensions

Fully assembled dimensions

A. Large base

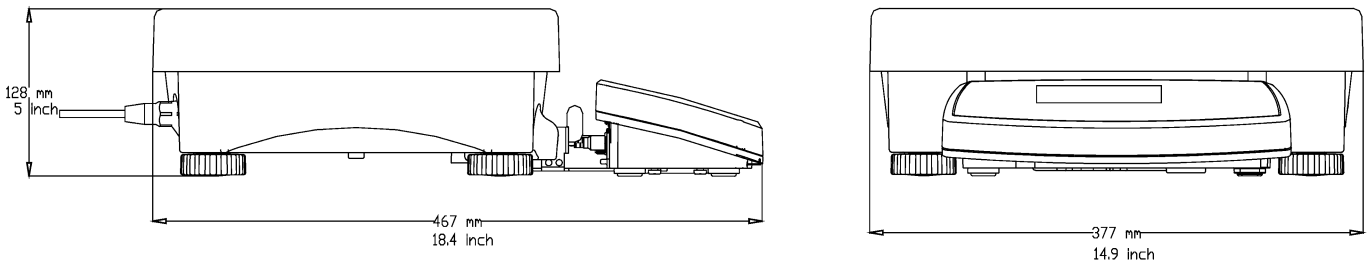

B. Small Base

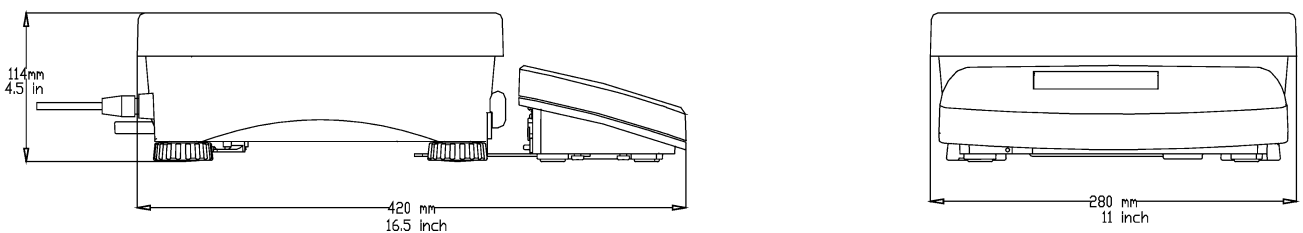

Figure 9-1. Ranger 7000 dimensions

9.3 Table of Geo Values

For weighing instruments verified by the manufacturer, the geo value indicates the country or geographical zone for which the instrument is verified. The Geo value set in the instrument (e.g. "Geo 18") appears briefly after switch-on or is specified on a label.

Note: GEO values are only applicable for models R71MD3, R71MD6, R71MD15 and R71MD35

TABLE 9-3. GEO CODES

Latitude		Elevation in meters										
		0	325	650	975	1300	1625	1950	2275	2600	2925	3250
		325	650	975	1300	1625	1950	2275	2600	2925	3250	3575
		Elevation in feet										
		0	1060	2130	3200	4260	5330	6400	7460	8530	9600	10660
		1060	2130	3200	4260	5330	6400	7460	8530	9600	10660	11730
		GEO value										
0°00'	5°46'	5	4	4	3	3	2	2	1	1	0	0
5°46'	9°52'	5	5	4	4	3	3	2	2	1	1	0
9°52'	12°44'	6	5	5	4	4	3	3	2	2	1	1
12°44'	15°06'	6	6	5	5	4	4	3	3	2	2	1
15°06'	17°10'	7	6	6	5	5	4	4	3	3	2	2
17°10'	19°02'	7	7	6	6	5	5	4	4	3	3	2
19°02'	20°45'	8	7	7	6	6	5	5	4	4	3	3
20°45'	22°22'	8	8	7	7	6	6	5	5	4	4	3
22°22'	23°54'	9	8	8	7	7	6	6	5	5	4	4
23°54'	25°21'	9	9	8	8	7	7	6	6	5	5	4
25°21'	26°45'	10	9	9	8	8	7	7	6	6	5	5
26°45'	28°06'	10	10	9	9	8	8	7	7	6	6	5
28°06'	29°25'	11	10	10	9	9	8	8	7	7	6	6
29°25'	30°41'	11	11	10	10	9	9	8	8	7	7	6
30°41'	31°56'	12	11	11	10	10	9	9	8	8	7	7
31°56'	33°09'	12	12	11	11	10	10	9	9	8	8	7
33°09'	34°21'	13	12	12	11	11	10	10	9	9	8	8
34°21'	35°31'	13	13	12	12	11	11	10	10	9	9	8
35°31'	36°41'	14	13	13	12	12	11	11	10	10	9	9
36°41'	37°50'	14	14	13	13	12	12	11	11	10	10	9
37°50'	38°58'	15	14	14	13	13	12	12	11	11	10	10
38°58'	40°05'	15	15	14	14	13	13	12	12	11	11	10
40°05'	41°12'	16	15	15	14	14	13	13	12	12	11	11
41°12'	42°19'	16	16	15	15	14	14	13	13	12	12	11
42°19'	43°26'	17	16	16	15	15	14	14	13	13	12	12
43°26'	44°32'	17	17	16	16	15	15	14	14	13	13	12
44°32'	45°38'	18	17	17	16	16	15	15	14	14	13	13
45°38'	46°45'	18	18	17	17	16	16	15	15	14	14	13
46°45'	47°51'	19	18	18	17	17	16	16	15	15	14	14
47°51'	48°58'	19	19	18	18	17	17	16	16	15	15	14
48°58'	50°06'	20	19	19	18	18	17	17	16	16	15	15
50°06'	51°13'	20	20	19	19	18	18	17	17	16	16	15
51°13'	52°22'	21	20	20	19	19	18	18	17	17	16	16
52°22'	53°31'	21	21	20	20	19	19	18	18	17	17	16
53°31'	54°41'	22	21	21	20	20	19	19	18	18	17	17
54°41'	55°52'	22	22	21	21	20	20	19	19	18	18	17
55°52'	57°04'	23	22	22	21	21	20	20	19	19	18	18
57°04'	58°17'	23	23	22	22	21	21	20	20	19	19	18
58°17'	59°32'	24	23	23	22	22	21	21	20	20	19	19
59°32'	60°49'	24	24	23	23	22	22	21	21	20	20	19
60°49'	62°90'	25	24	24	23	23	22	22	21	21	20	20
62°90'	63°30'	25	25	24	24	23	23	22	22	21	21	20
63°30'	64°55'	26	25	25	24	24	23	23	22	22	21	21
64°55'	66°24'	26	26	25	25	24	24	23	23	22	22	21
66°24'	67°57'	27	26	26	25	25	24	24	23	23	22	22
67°57'	69°35'	27	27	26	26	25	25	24	24	23	23	22
69°35'	71°21'	28	27	27	26	26	25	25	24	24	23	23
71°21'	73°16'	28	28	27	27	26	26	25	25	24	24	23
73°16'	75°24'	29	28	28	27	27	26	26	25	25	24	24
75°24'	77°52'	29	29	28	28	27	27	26	26	25	25	24
77°52'	80°56'	30	29	29	28	28	27	27	26	26	25	25
80°56'	85°45'	30	30	29	29	28	28	27	27	26	26	25
85°45'	90°00'	31	30	30	29	29	28	28	27	27	26	26

9.4 Options

TABLE 9-4. OPTIONS

DESCRIPTION	PART NUMBER
Rechargeable Battery Kit, EX HiCap, R71	30041295
Accessory Tower Kit, R71	30095408
Accessory RS232, Kit, R31, RC31, V71, R71	30037448
Accessory 2 nd Platform Kit, R71	30097590
Accessory Discrete I/O, R71	30097591
Accessory Ethernet Kit, R31, RC31, V71, R71	30037447
Alibi Memory Kit, T71, R71	80500503
Accessory Extension Cable 9 Meters, R71	30101495

9.5 Button Icons List

TABLE 9-5. BUTTON ICONS













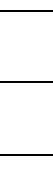
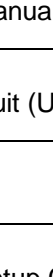
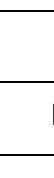
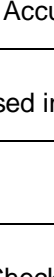

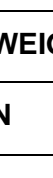

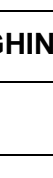
WEIGHING APPLICATION			
ICON	FUNCTION	ICON	FUNCTION
	Setup Weighing mode configurations		Edit selected record (used in Library)
	Manual Accumulation		Recall selected record (used in Library)
	Quit (Used in Library)		Delete selected record (used in Library)
	Add a record (used in Library)		
COUNTING APPLICATION			
	Setup Counting mode configurations		Add a record (Used in Library)
	Set APW (Average Piece Weight) by number of samples		Delete selected record (used in Library)
	Enter APW (Average Piece Weight) value directly		Recall selected record (used in Library)
	Manual Accumulation		Edit selected record (used in Library)
	Quit (Used in Library)		
CHECK APPLICATION			
	Setup Check mode configurations		Quit (Used in Library)
	Change Check limits		Add a record (Used in Library)
	Set APW (Average Piece Weight) by number of samples		Delete selected record (used in Library)
	Enter APW (Average Piece Weight) value directly		Recall selected record (used in Library)
	Manual Accumulation		Edit selected record (used in Library)
	Switch the Check Limit's input method		

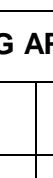
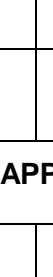
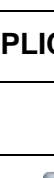
TABLE 9-5. BUTTON ICONS (Continued)

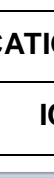
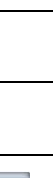
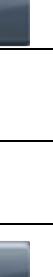
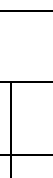

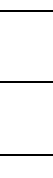
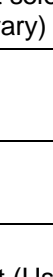

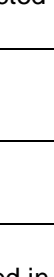

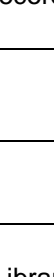
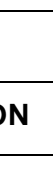

















DENSITY APPLICATION			
ICON	FUNCTION	ICON	FUNCTION
	Setup Density mode configurations		Enter liquid density
	Accept current weight		Start
	Set water temperature		Cancel
FILLING APPLICATION			
ICON	FUNCTION	ICON	FUNCTION
	Setup Filling mode configurations		Switch the Setpoints' input method
	Set input value or current weight on the pan as target		Quit (Used in Library)
	Set Target, Setpoint1 and Setpoint2 value		Add a record (Used in Library)
	Stop		Delete selected record (used in Library)
	Start		Recall selected record (used in Library)
	Manual Accumulation		Edit selected record (used in Library)
DYNAMIC APPLICATION			
ICON	FUNCTION	ICON	FUNCTION
	Setup Dynamic mode configurations		Start
	Set Averaging Time		Cancel
	Manual Accumulation		Reset

TABLE 9-5. BUTTON ICONS (Continued)































DIFFERENTIAL APPLICATION			
ICON	FUNCTION	ICON	FUNCTION
	Setup Differential mode configurations		Accept current weight
	Edit Items		Reset
PERCENT APPLICATION			
ICON	FUNCTION	ICON	FUNCTION
	Setup Percent mode configurations		Manual Accumulation
	Set reference weight		
FORMULATION APPLICATION			
ICON	FUNCTION	ICON	FUNCTION
	Setup Formulation mode configurations		Print formulation result
	Set factor		View selected record (Used in Library)
	Start		Edit record Name (Used in Library)
	Select		Delete selected record (Used in Library)
	Reset		Go back to previous screen
	Next component		Go to next screen
	Last Component		Add a record (Used in Library)
	Quit (Used in Library)		Edit selected record (used in Library)
	Save formulation result as a new receipt		



TABLE 9-5. BUTTON ICONS (Continued)

ICON	FUNCTION	ICON	FUNCTION
	Guest		Print Range
	Login		Locate Alibi record

10. COMPLIANCE

Compliance to the following standards is indicated by the corresponding mark on the product.

Mark	Standard
	This product conforms to the EMC Directive 2004/108/EC, the Low Voltage Directive 2006/95/EC and the Non-automatic Weighing Instruments Directive 2009/23/EC. The complete Declaration of Conformity is available online at europe.ohaus.com/europe/en/home/support/compliance.aspx .
	AS/NZS CISPR 11, AS/NZS 61000.4.3
	UL Std. No. 60950-1 (2 nd edition) CAN/CSA-C22.2 No. 61010-1-04

	Important notice for verified weighing instruments Weighing instruments verified at the place of manufacture bear one of the preceding marks on the packing label and the green 'M' (metrology) sticker on the descriptive plate. They may be put into service immediately.
	Weighing instruments to be verified in two stages have no green 'M' (metrology) on the descriptive plate and bear one of the preceding identification marks on the packing label. The second stage of the initial verification must be carried out by the approved service organization of the authorized representative within the EC or by the national weights and measures (W+M) authorities. The first stage of the initial verification has been carried out at the manufacturer's work. It comprises all tests according to the adopted European standard EN45501:1992, paragraph 8.2.2. If national regulations limit the validity period of the verification, the user of the weighing instrument must strictly observe the re-verification period and inform the respective W+M authorities.

FCC Note

This equipment has been tested and found to comply with the limits for a Class A digital device, pursuant to Part 15 of the FCC Rules. These limits are designed to provide reasonable protection against harmful interference when the equipment is operated in a commercial environment. This equipment generates, uses, and can radiate radio frequency energy and, if not installed and used in accordance with the instruction manual, may cause harmful interference to radio communications. Operation of this equipment in a residential area is likely to cause harmful interference in which case the user will be required to correct the interference at his own expense.

Industry Canada Note

This Class A digital apparatus complies with Canadian ICES-001.

ISO 9001 Registration

In 1994, OHAUS Corporation, USA, was awarded a certificate of registration to ISO 9001 by Bureau Veritas Quality International (BVQI), confirming that the OHAUS quality management system is compliant with the ISO 9001 standard's requirements. On June 21, 2012, OHAUS Corporation, USA, was re-registered to the ISO 9001:2008 standard.

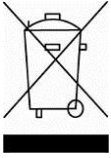
Disposal

In conformance with the European Directive 2002/96/EC on Waste Electrical and Electronic Equipment (WEEE) this device may not be disposed of in domestic waste. This also applies to countries outside the EU, per their specific requirements.

The Batteries Directive 2006/66/EC introduces new requirements from September 2008 on removability of batteries from waste equipment in EU Member States. To comply with this Directive, this device has been designed for safe removal of the batteries at end-of-life by a waste treatment facility.

Please dispose of this product in accordance with local regulations at the collecting point specified for electrical and electronic equipment.

If you have any questions, please contact the responsible authority or the distributor from which you purchased this device.

Should this device be passed on to other parties (for private or professional use), the content of this regulation must also be related.

Disposal instructions in Europe are available online at europe.ohaus.com/europe/en/home/support/weee.aspx.

Thank you for your contribution to environmental protection.

LIMITED WARRANTY

Ohaus products are warranted against defects in materials and workmanship from the date of delivery through the duration of the warranty period. During the warranty period Ohaus will repair, or, at its option, replace any component(s) that proves to be defective at no charge, provided that the product is returned, freight prepaid, to Ohaus.

This warranty does not apply if the product has been damaged by accident or misuse, exposed to radioactive or corrosive materials, has foreign material penetrating to the inside of the product, or as a result of service or modification by other than Ohaus. In lieu of a properly returned warranty registration card, the warranty period shall begin on the date of shipment to the authorized dealer. No other express or implied warranty is given by Ohaus Corporation. Ohaus Corporation shall not be liable for any consequential damages.

As warranty legislation differs from state to state and country to country, please contact Ohaus or your local Ohaus dealer for further details.



Ohaus® and Ranger® are either registered trademarks or trademarks of Ohaus Corporation in the United States and/or other countries.
Microsoft®, Windows® and Excel® are either registered trademarks or trademarks of Microsoft Corporation in the United States and/or other countries.

Ohaus Corporation
7 Campus Drive
Suite 310
Parsippany, NJ 07054 USA
Tel: +1 (973) 377-9000
Fax: +1 (973) 944-7177

With offices worldwide
www.ohaus.com



* 3 0 1 2 5 4 9 1 *

P/N 30125491 © 2013 Ohaus Corporation, all rights reserved.